

INTERIOR ELEVATION

**THERMOSTOP MODEL
ENERGEX MARK IV-266**
DOOR THICKNESS = 100mm (4")

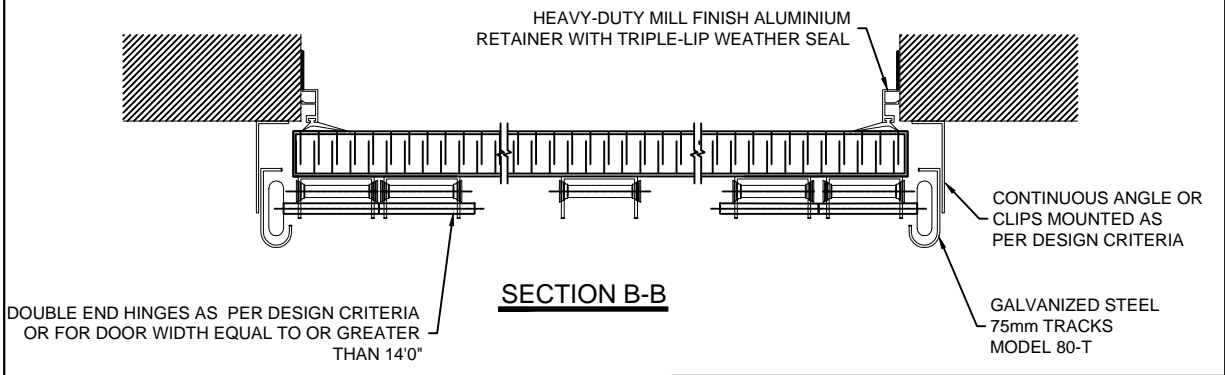

APPROVED FOR MANUFACTURING BY:
Name:.....
Signature:.....
Date:.....

MODEL	QTY.	DOOR		No. of PAN.	No. of SECT.	OPERATION
		WIDTH	HEIGHT			
ENERGEX MARK IV-266	X	XXXXmm	XXXXmm	X	X	ELECTRIC OPERATOR BY THERMOSTOP
		XX' XX"	XX' XX"			
		OPENING				
		XXXXmm	XXXXmm			
		XX' XX"	XX' XX"			

THERMOSTOP INC.
3775 BOULEVARD LOSCH, ST-HUBERT, QUÉBEC J3Y 5T7
PROJECT NAME : XXXXXXXXXXXX
DISTRIBUTOR : XXXXXXXXXXXX
CONTRACTOR : XXXXXXXXXXXX
ARCHITECT : XXXXXXXXXXXX

NOTES:
DRAWINGS NOT TO SCALE
ALL DIMENSIONS ARE IN mm

DATE	DRAWN BY	VERIFIED BY	QUOTE No.	DRAWING No.	REVISION:
xx/xx/xxxx	X.X.	L.H.	XXXXXX	XX/XX	XX

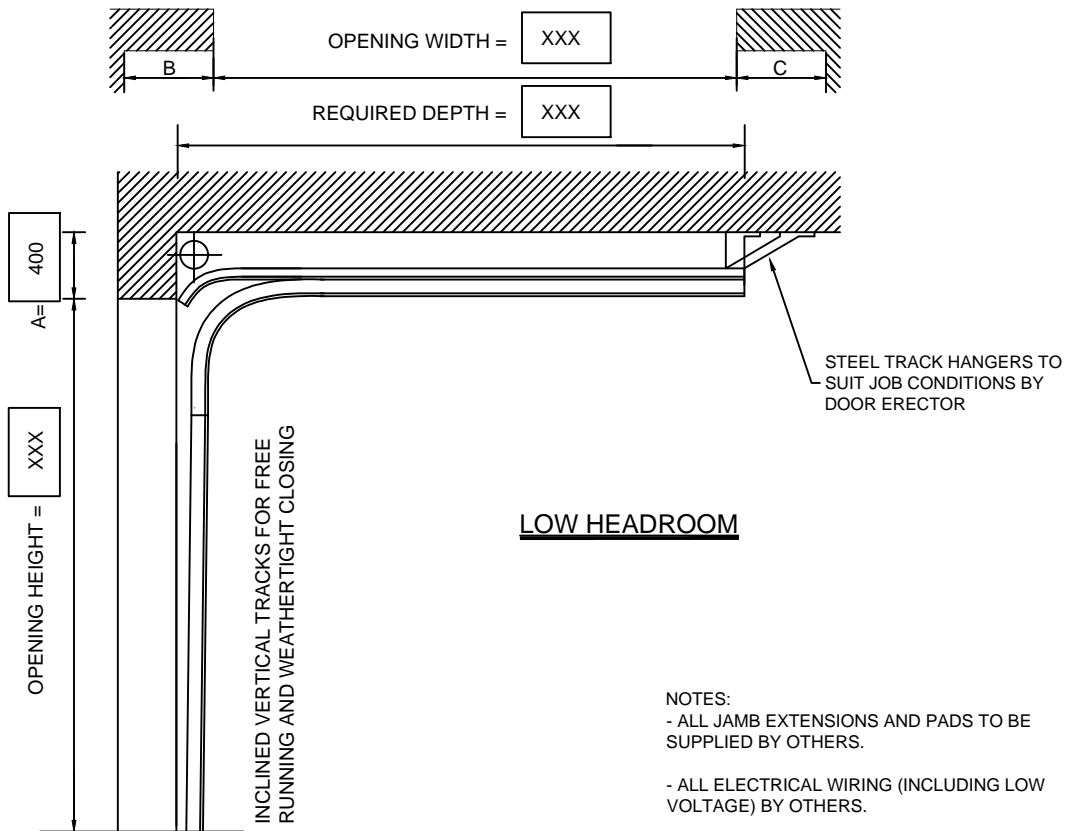
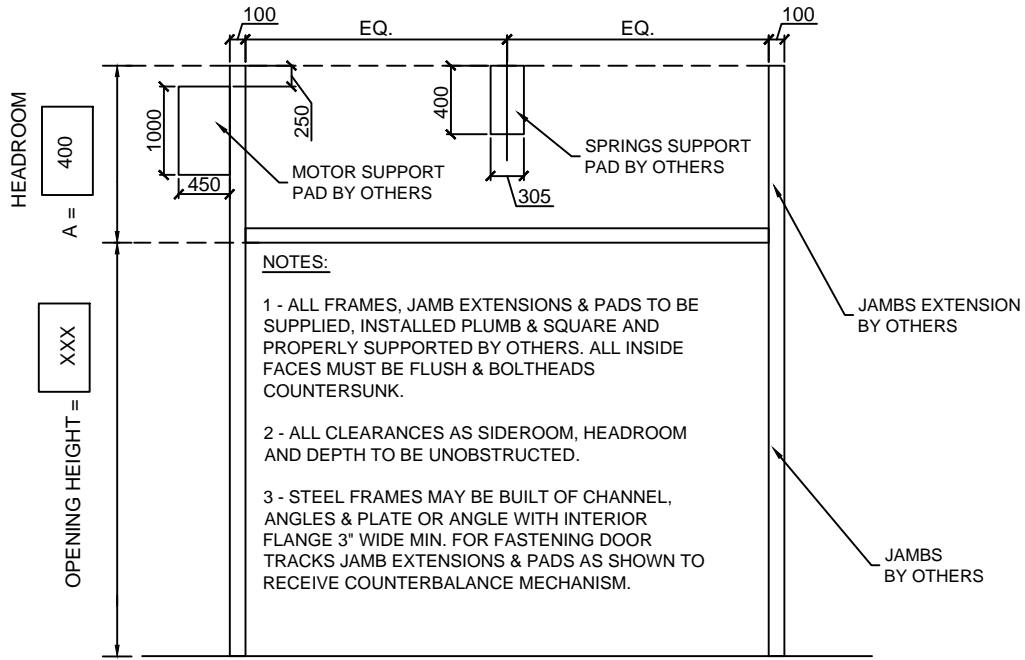

APPROVED FOR MANUFACTURING BY:
 Nom:.....
 Signature:.....
 Date:.....

MODEL	QTY.	No DOOR	CLEARANCE REQ.			DEPTH	SECT.	GLASS
			A	B	C			
ENERGEX MARK IV-266	X		400mm	550mm	100mm	XXmm	X	GLASS TYPE

THERMOSTOP INC.
 3775 BOULEVARD LOSCH, ST-HUBERT, QUÉBEC J3Y 5T7
 PROJECT NAME : XXXXXXXXXXXX
 DISTRIBUTOR : XXXXXXXXXXXX
 CONTRACTOR : XXXXXXXXXXXX
 ARCHITECT : XXXXXXXXXXXX

NOTE :
 DRAWINGS NOT TO SCALE
 ALL DIMENSIONS ARE IN mm

DATE	DRAWN BY	VERIFIED BY	QUOTE No.	DRAWING No.	REVISION:
XX/XX/XXXX	X.X.	L.H.	XXXXXXXX	XX/XX	XX

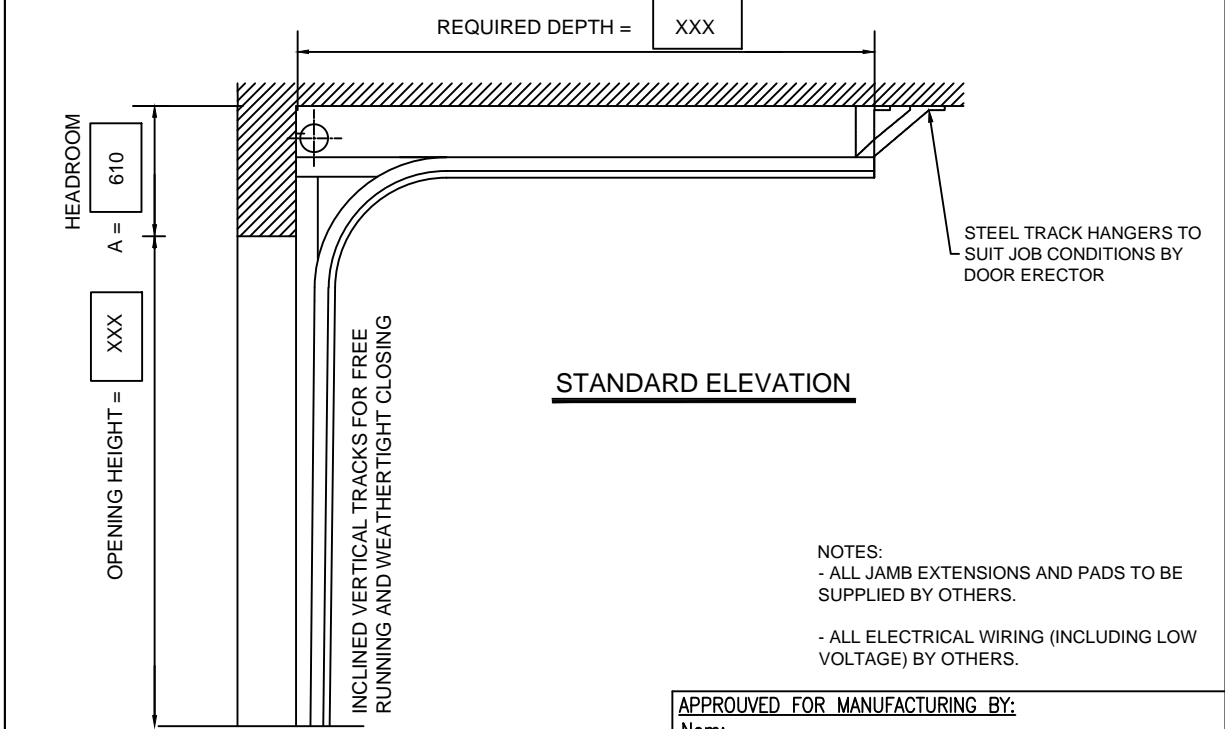
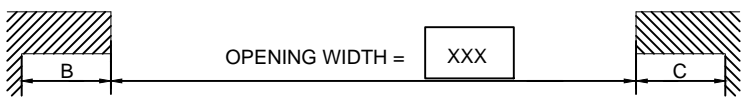
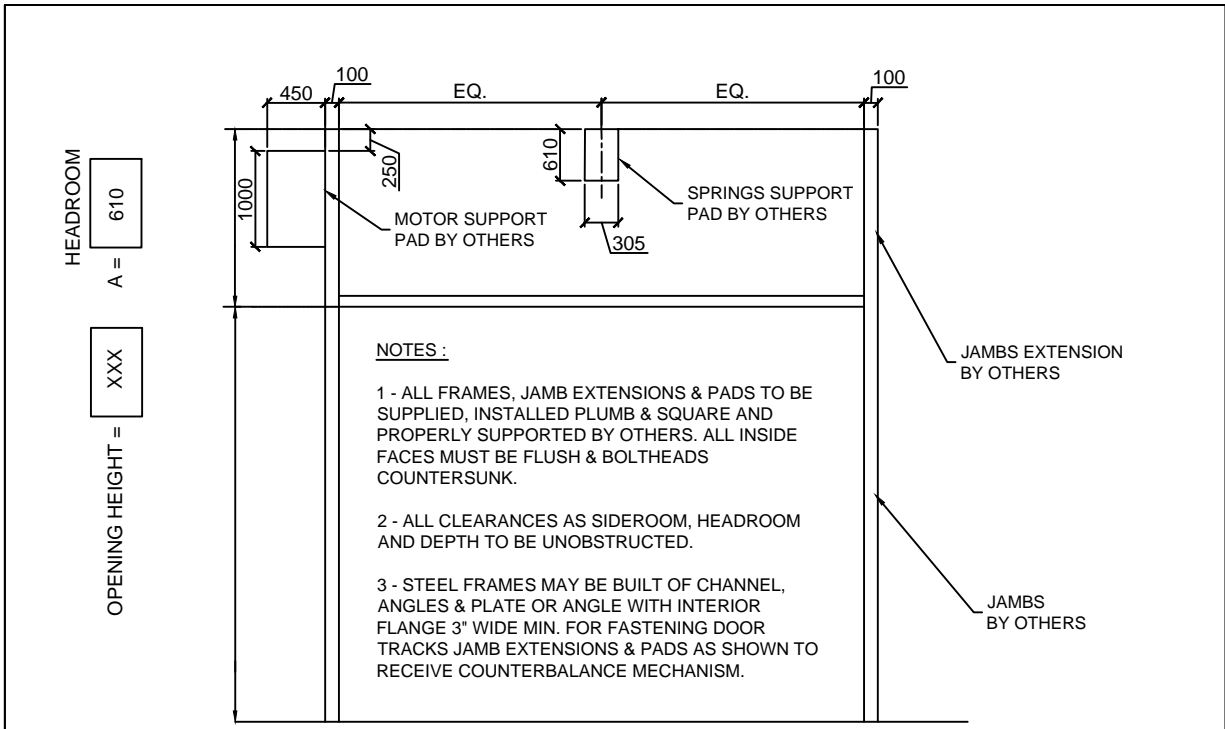

APPROVED FOR MANUFACTURING BY:
 Nom:.....
 Signature:.....
 Date:.....

MODEL	QTY.	No DOOR	CLEARANCE REQ.			DEPTH	SECT.	GLASS
			A	B	C			
ENERGEX MARK IV-266	X		610mm	550mm	100mm	XXmm	X	GLASS TYPE

THERMOSTOP INC.
 3775 BOULEVARD LOSCH, ST-HUBERT, QUÉBEC J3Y 5T7
 PROJECT NAME : XXXXXXXXXXXX
 DISTRIBUTOR : XXXXXXXXXXXX
 CONTRACTOR : XXXXXXXXXXXX
 ARCHITECT : XXXXXXXXXXXX

NOTE:
 DRAWINGS NOT TO SCALE
 ALL DIMENSIONS ARE IN mm

DATE	DRAWN BY	VERIFIED BY	QUOTE No.	DRAWING No.	REVISION:
XX/XX/XXXX	X.X.	L.H.	XXXXXXX	XX/XX	XX

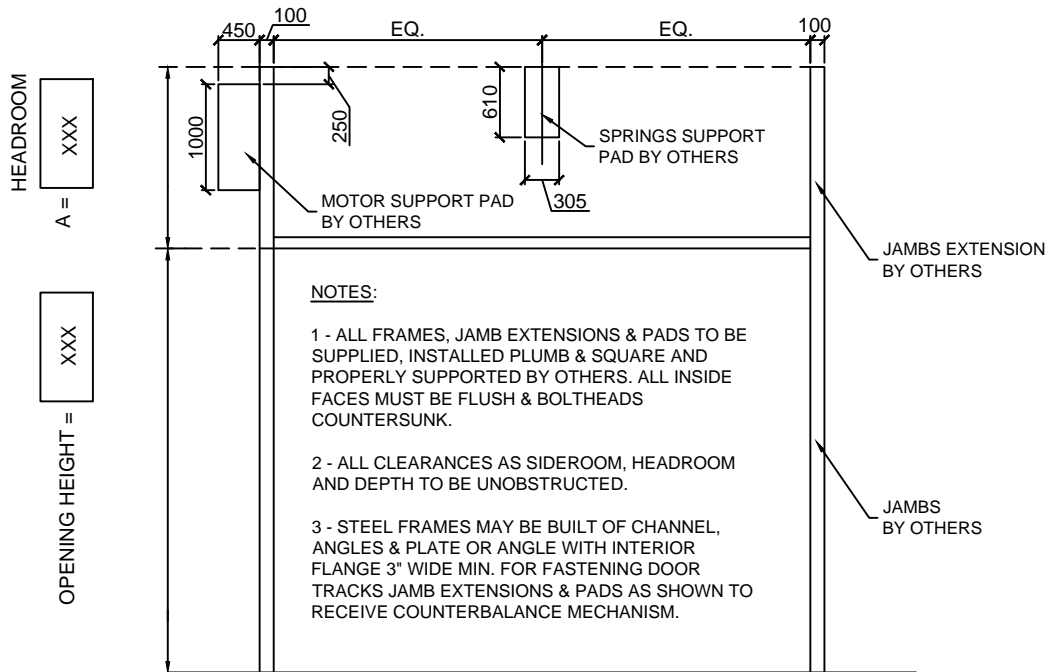

NOTES:

- 1 - ALL FRAMES, JAMB EXTENSIONS & PADS TO BE SUPPLIED, INSTALLED PLUMB & SQUARE AND PROPERLY SUPPORTED BY OTHERS. ALL INSIDE FACES MUST BE FLUSH & BOLTHEADS COUNTERSUNK.
- 2 - ALL CLEARANCES AS SIDEROOM, HEADROOM AND DEPTH TO BE UNOBSTRUCTED.
- 3 - STEEL FRAMES MAY BE BUILT OF CHANNEL, ANGLES & PLATE OR ANGLE WITH INTERIOR FLANGE 3" WIDE MIN. FOR FASTENING DOOR TRACKS JAMB EXTENSIONS & PADS AS SHOWN TO RECEIVE COUNTERBALANCE MECHANISM.

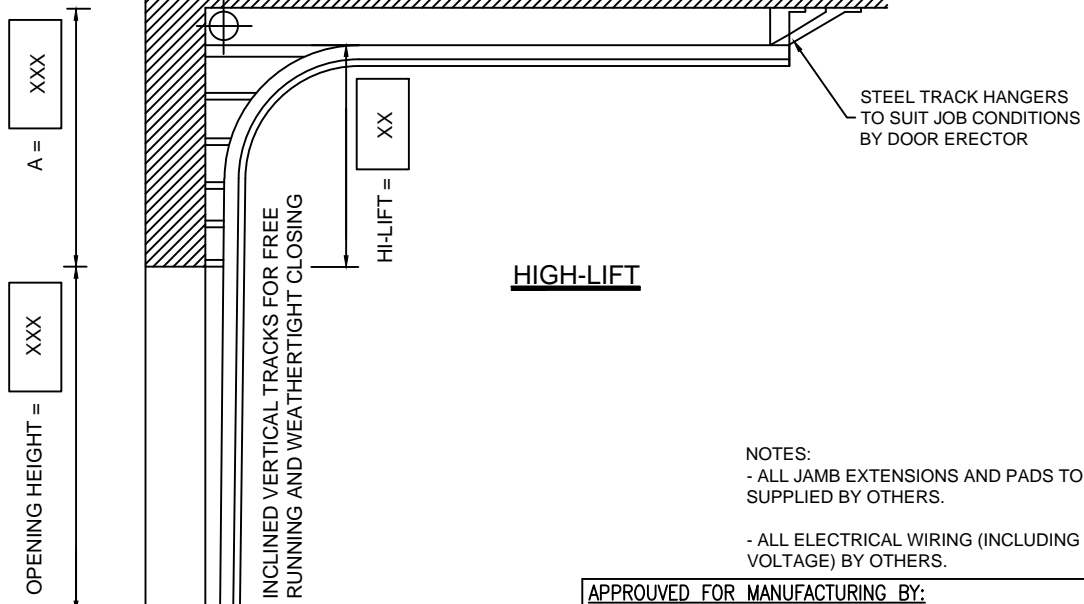
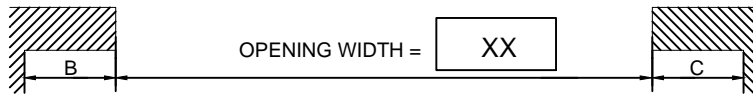

- NOTES:**
- ALL JAMB EXTENSIONS AND PADS TO BE SUPPLIED BY OTHERS.
 - ALL ELECTRICAL WIRING (INCLUDING LOW VOLTAGE) BY OTHERS.

APPROVED FOR MANUFACTURING BY:
 Nom:.....
 Signature:.....
 Date:.....

MODEL	QTY.	No DOOR	CLEARANCE REQ.			DEPTH	SECT.	GLASS
			A	B	C			
ENERGEX MARK IV-266	X		XXmm	550mm	100mm	XXmm	X	GLASS TYPE

NOTE:
 DRAWINGS NOT TO SCALE
 ALL DIMENSIONS ARE IN mm

THERMOSTOP INC.
 3775 BOULEVARD LOSCH, ST-HUBERT, QUÉBEC J3Y 5T7
 PROJECT NAME : XXXXXXXXXXXX
 DISTRIBUTOR : XXXXXXXXXXXX
 CONTRACTOR : XXXXXXXXXXXX
 ARCHITECT : XXXXXXXXXXXX

DATE XX/XX/XXXX	DRAWN BY X.X.	VERIFIED BY L.H.	QUOTE No. XXXXXXX	DRAWING No. XX/XX	REVISION: XX
--------------------	------------------	---------------------	----------------------	----------------------	-----------------

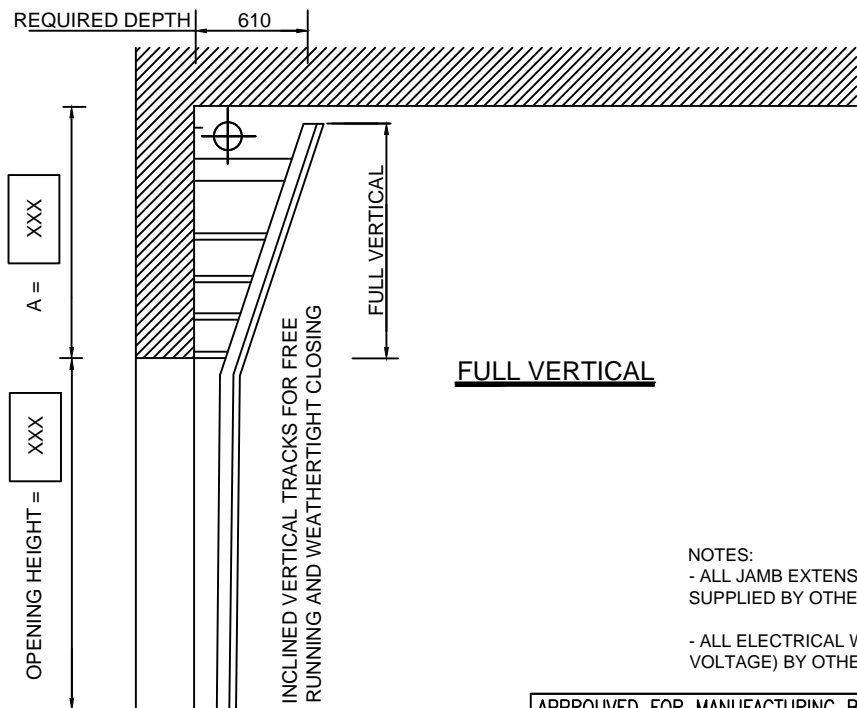
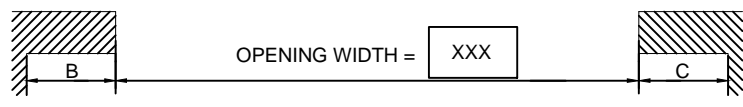
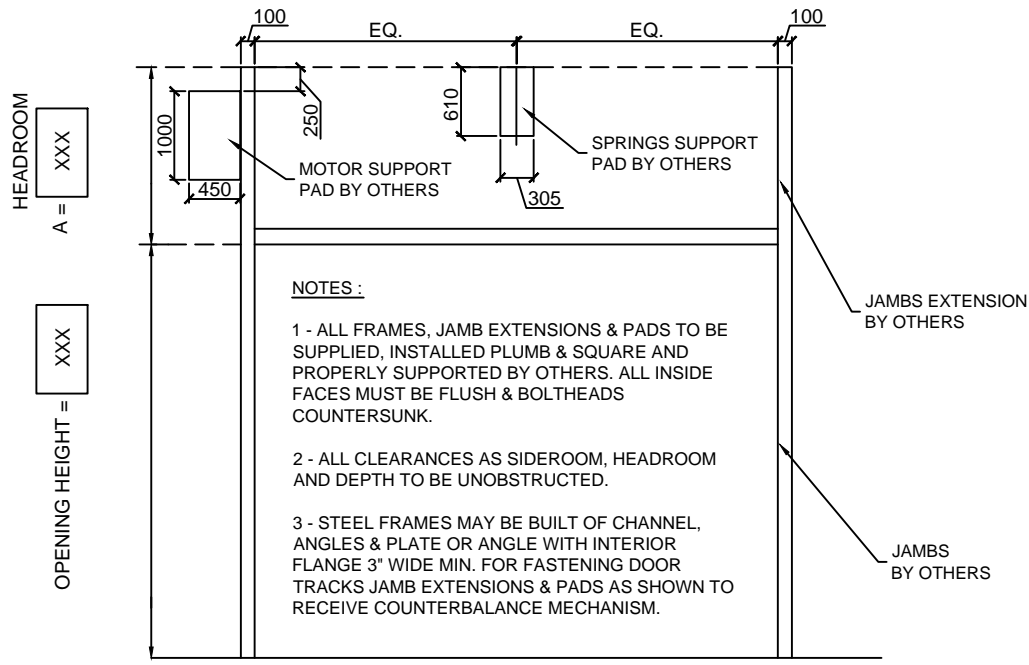

MODEL	QTY.	No DOOR	CLEARANCE REQ.			DEPTH	SECT.	GLASS
			A	B	C			
ENERGEX MARK IV-266	X		XXmm	550mm	100mm	610mm	X	GLASS TYPE

NOTE :
DRAWINGS NOT TO SCALE
ALL DIMENSIONS ARE IN mm

APPROVED FOR MANUFACTURING BY:
Nom:.....
Signature:.....
Date:.....

THERMOSTOP INC.
3775 BOULEVARD LOSCH, ST-HUBERT, QUÉBEC J3Y 5T7

PROJECT NAME : XXXXXXXXXXXX
DISTRIBUTOR : XXXXXXXXXXXX
CONTRACTOR : XXXXXXXXXXXX
ARCHITECT : XXXXXXXXXXXX

DATE xx/xx/xxxx	DRAWN BY X.X.	VERIFIED BY L.H.	QUOTE No. XXXXXXX	DRAWING No. xx/xx	REVISION: XX
--------------------	------------------	---------------------	----------------------	----------------------	-----------------