

**INTERIOR ELEVATION**

**SECTION A-A**

**THERMOSTOP MODEL  
SENTINEL MARK II-166**  
DOOR THICKNESS = 50mm (2")

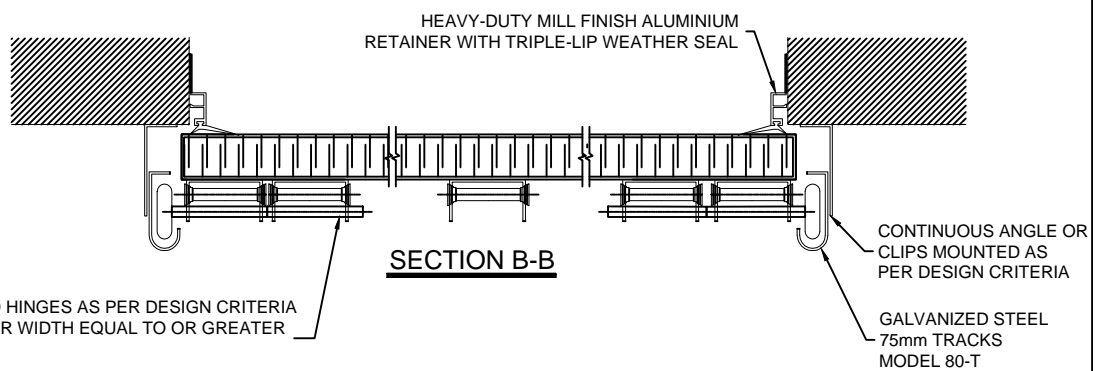

**SECTION B-B**

DOUBLE END HINGES AS PER DESIGN CRITERIA  
OR FOR DOOR WIDTH EQUAL TO OR GREATER  
THAN 14'0"

MODEL	QTY.	DOOR		No. of PAN.	No. of SECT.	OPERATION	
		WIDTH	HEIGHT				
SENTINEL MARK II-166	X	XXXXmm	XXXXmm	X	X	ELECTRIC OPERATOR BY THERMOSTOP	
		XX' XX"	XX' XX"				
		OPENING					
		XXXXmm	XXXXmm				
		XX' XX"	XX' XX"				

NOTES:  
DRAWINGS NOT TO SCALE  
ALL DIMENSIONS ARE IN mm

APPROVED FOR MANUFACTURING BY:  
Name:.....  
Signature:.....  
Date:.....

**THERMOSTOP INC.**  
3775 BOULEVARD LOSCH, ST-HUBERT, QUÉBEC J5Y 5T7  
PROJECT NAME : XXXXXXXXXXXX  
DISTRIBUTOR : XXXXXXXXXXXX  
CONTRACTOR : XXXXXXXXXXXX  
ARCHITECT : XXXXXXXXXXXX

DATE	DRAWN BY	VERIFIED BY	QUOTE No.	DRAWING No.	REVISION:
XX/XX/XXXX	X.X.	L.H.	XXXXXXX	XX/XX	XX

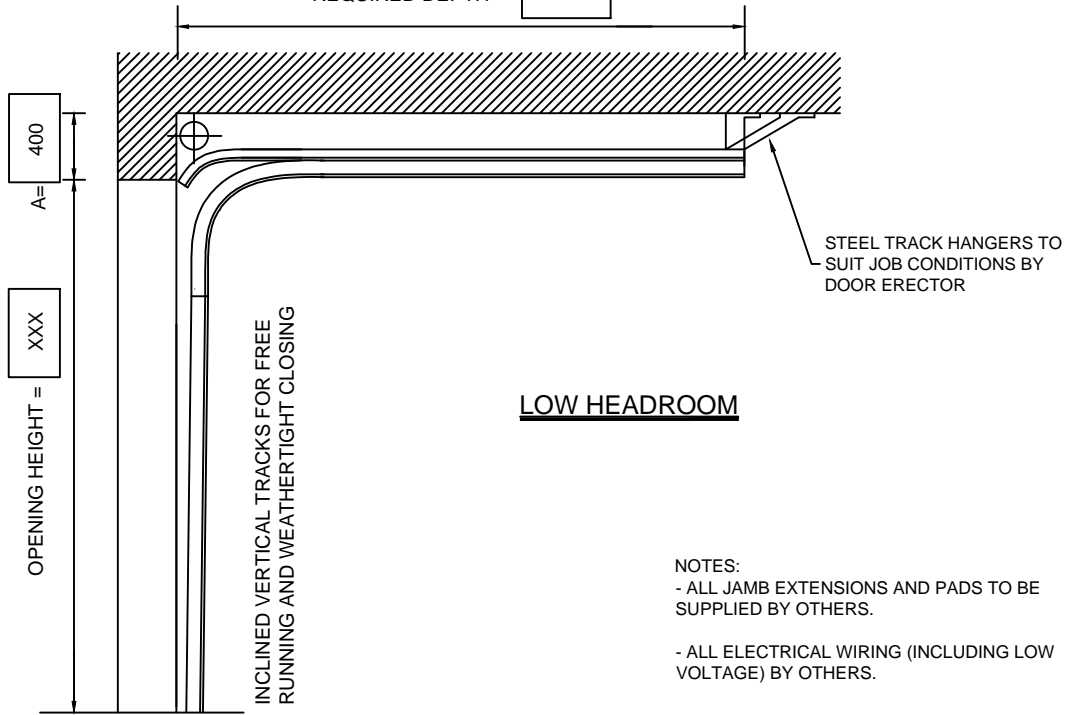
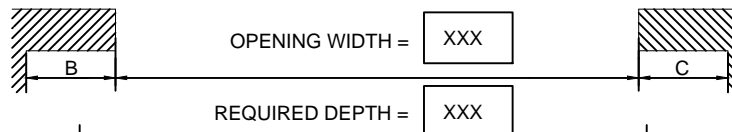
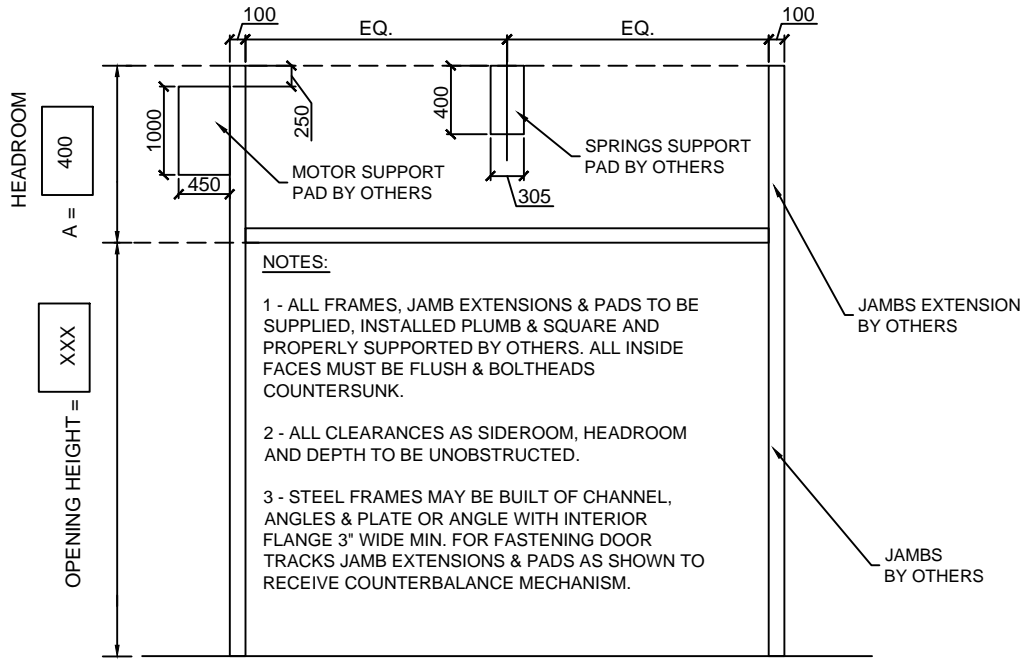

**LOW HEADROOM**

- NOTES:
- ALL JAMB EXTENSIONS AND PADS TO BE SUPPLIED BY OTHERS.
  - ALL ELECTRICAL WIRING (INCLUDING LOW VOLTAGE) BY OTHERS.

APPROVED FOR MANUFACTURING BY:  
 Nom:.....  
 Signature:.....  
 Date:.....

MODEL	QTY.	No DOOR	CLEARANCE REQ.			DEPTH	SECT.	GLASS
			A	B	C			
SENTINEL MARK II-166	X		400mm	550mm	100mm	XXmm	X	GLASS TYPE

**THERMOSTOP INC.**  
 3775 BOULEVARD LOSCH, ST-HUBERT, QUÉBEC J3Y 5T7  
 PROJECT NAME : XXXXXXXXXXXX  
 DISTRIBUTOR : XXXXXXXXXXXX  
 CONTRACTOR : XXXXXXXXXXXX  
 ARCHITECT : XXXXXXXXXXXX

NOTE :  
 DRAWINGS NOT TO SCALE  
 ALL DIMENSIONS ARE IN mm

DATE	DRAWN BY	VERIFIED BY	QUOTE No.	DRAWING No.	REVISION:
XX/XX/XXXX	X.X.	L.H.	XXXXXXXX	XX/XX	XX

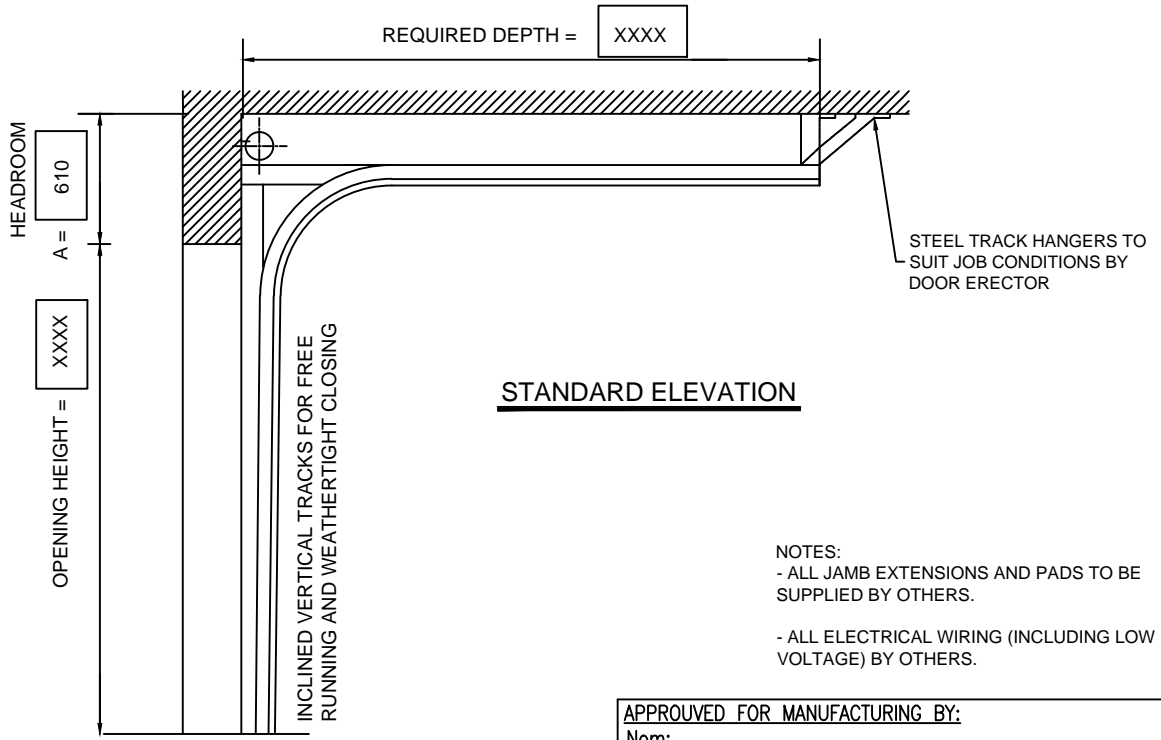
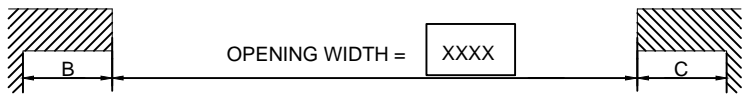
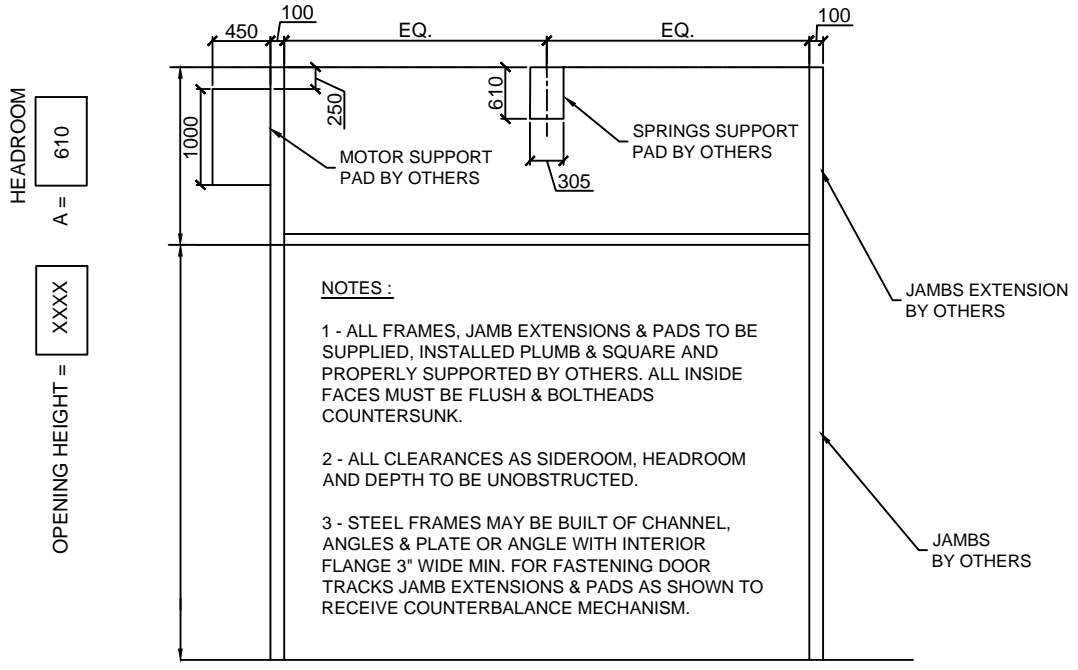

**NOTES:**  
 - ALL JAMB EXTENSIONS AND PADS TO BE SUPPLIED BY OTHERS.  
 - ALL ELECTRICAL WIRING (INCLUDING LOW VOLTAGE) BY OTHERS.

**APPROVED FOR MANUFACTURING BY:**  
 Nom:.....  
 Signature:.....  
 Date:.....

MODEL	QTY.	No DOOR	CLEARANCE REQ.			DEPTH	SECT.	GLASS
			A	B	C			
SENTINEL MARK II-166	X		610mm	550mm	100mm	XXmm	X	GLASS TYPE

**THERMOSTOP INC.**  
 3775 BOULEVARD LOSCH, ST-HUBERT, QUÉBEC J3Y 5T7  
 PROJECT NAME : XXXXXXXXXXXX  
 DISTRIBUTOR : XXXXXXXXXXXX  
 CONTRACTOR : XXXXXXXXXXXX  
 ARCHITECT : XXXXXXXXXXXX

**NOTE :**  
 DRAWINGS NOT TO SCALE  
 ALL DIMENSIONS ARE IN mm

DATE	DRAWN BY	VERIFIED BY	QUOTE No.	DRAWING No.	REVISION:
XX/XX/XXXX	X.X.	L.H.	XXXXXX	XX/XX	XX

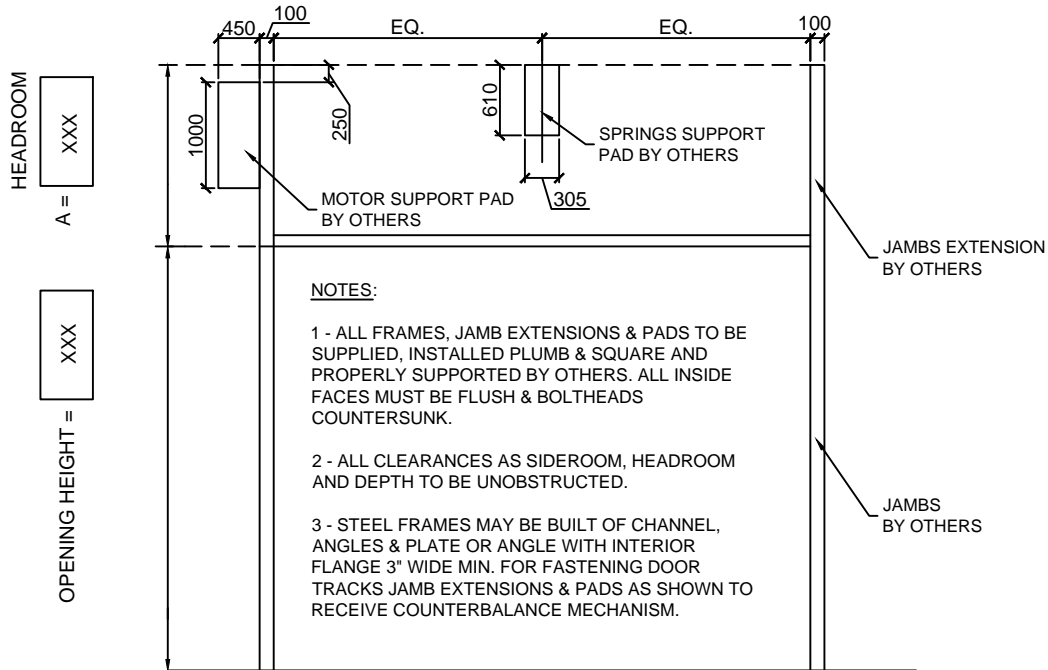

**NOTES:**

- 1 - ALL FRAMES, JAMB EXTENSIONS & PADS TO BE SUPPLIED, INSTALLED PLUMB & SQUARE AND PROPERLY SUPPORTED BY OTHERS. ALL INSIDE FACES MUST BE FLUSH & BOLTHEADS COUNTERSUNK.
- 2 - ALL CLEARANCES AS SIDEROOM, HEADROOM AND DEPTH TO BE UNOBSTRUCTED.
- 3 - STEEL FRAMES MAY BE BUILT OF CHANNEL, ANGLES & PLATE OR ANGLE WITH INTERIOR FLANGE 3" WIDE MIN. FOR FASTENING DOOR TRACKS JAMB EXTENSIONS & PADS AS SHOWN TO RECEIVE COUNTERBALANCE MECHANISM.

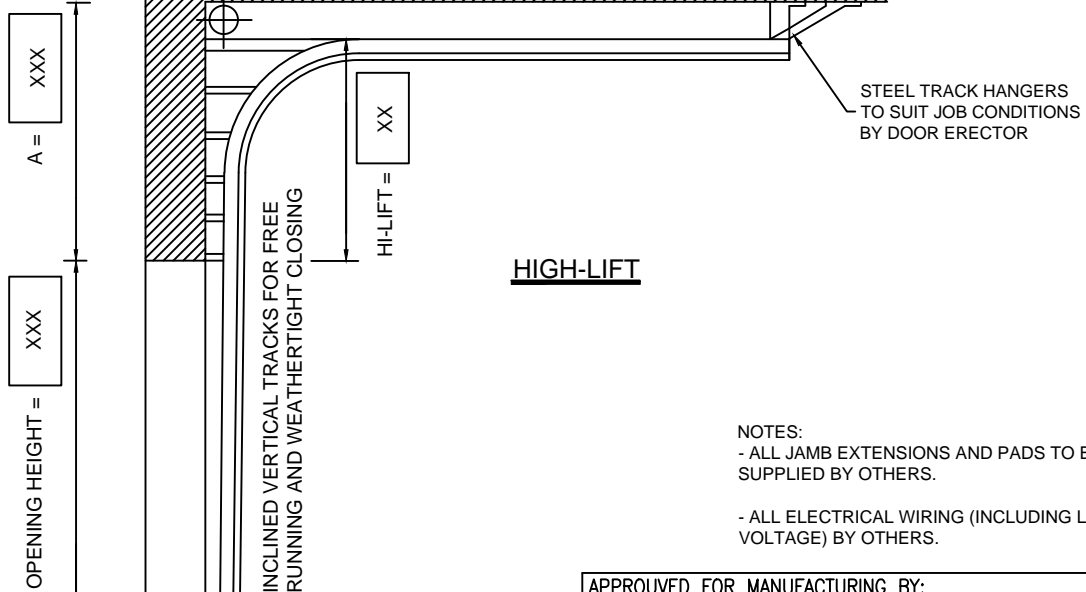
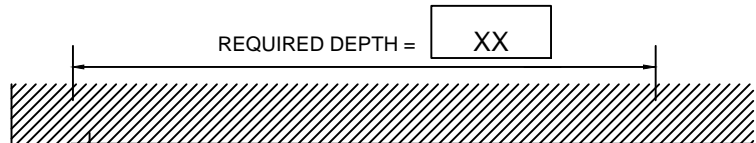
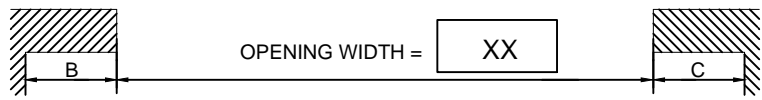

**NOTES:**

- ALL JAMB EXTENSIONS AND PADS TO BE SUPPLIED BY OTHERS.
- ALL ELECTRICAL WIRING (INCLUDING LOW VOLTAGE) BY OTHERS.

**APPROVED FOR MANUFACTURING BY:**  
 Nom:.....  
 Signature:.....  
 Date:.....

MODEL	QTY.	No DOOR	CLEARANCE REQ.			DEPTH	SECT.	GLASS
			A	B	C			
SENTINEL MARK II-166	X		XXmm	550mm	100mm	XXmm	X	GLASS TYPE

**NOTE:**  
 DRAWINGS NOT TO SCALE  
 ALL DIMENSIONS ARE IN mm

**THERMOSTOP INC.**  
 3775 BOULEVARD LOSCH, ST-HUBERT, QUÉBEC J3Y 5T7

PROJECT NAME : XXXXXXXXXXXX  
 DISTRIBUTOR : XXXXXXXXXXXX  
 CONTRACTOR : XXXXXXXXXXXX  
 ARCHITECT : XXXXXXXXXXXX

DATE XX/XX/XXXX	DRAWN BY X.X.	VERIFIED BY L.H.	QUOTE No. XXXXXXX	DRAWING No. XX/XX	REVISION: XX
--------------------	------------------	---------------------	----------------------	----------------------	-----------------

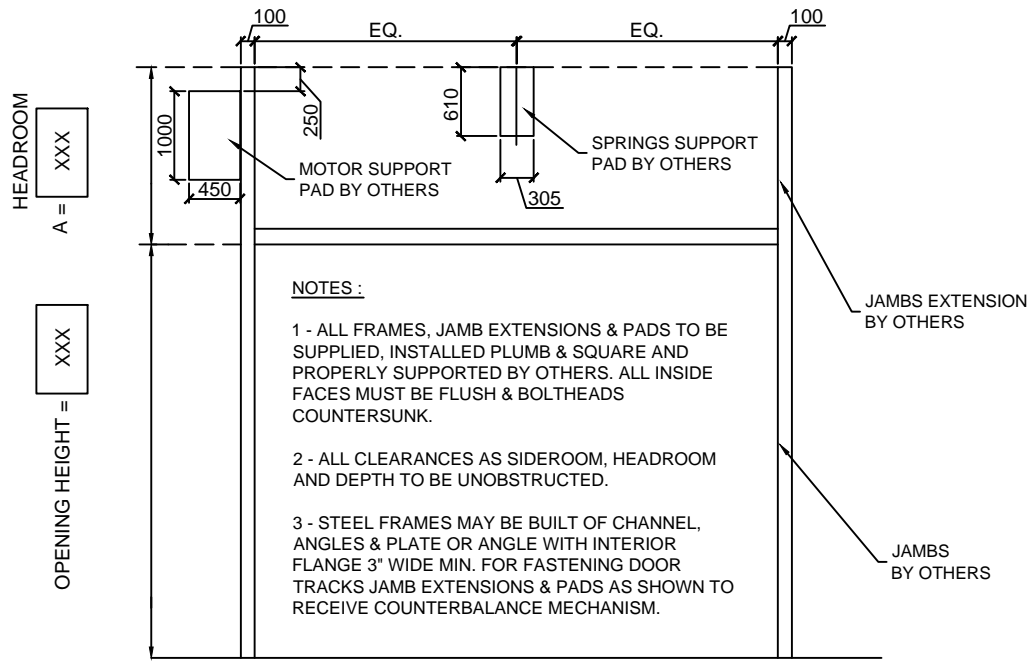

**NOTES :**

- 1 - ALL FRAMES, JAMB EXTENSIONS & PADS TO BE SUPPLIED, INSTALLED PLUMB & SQUARE AND PROPERLY SUPPORTED BY OTHERS. ALL INSIDE FACES MUST BE FLUSH & BOLTHEADS COUNTERSUNK.
- 2 - ALL CLEARANCES AS SIDEROOM, HEADROOM AND DEPTH TO BE UNOBSTRUCTED.
- 3 - STEEL FRAMES MAY BE BUILT OF CHANNEL, ANGLES & PLATE OR ANGLE WITH INTERIOR FLANGE 3" WIDE MIN. FOR FASTENING DOOR TRACKS JAMB EXTENSIONS & PADS AS SHOWN TO RECEIVE COUNTERBALANCE MECHANISM.

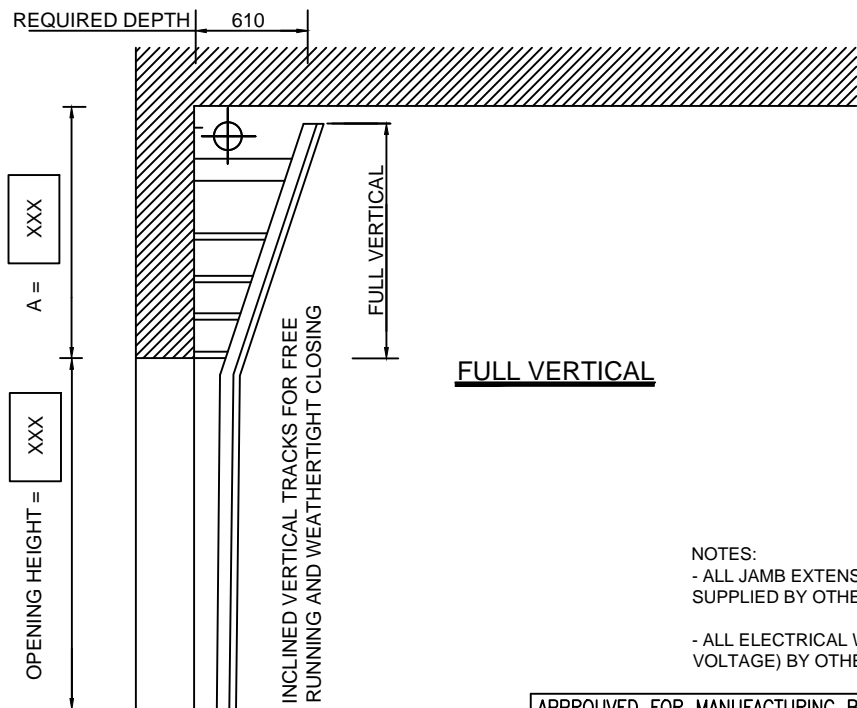
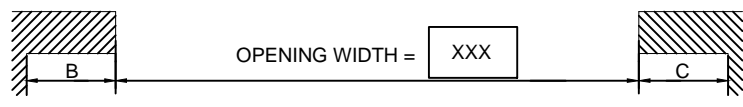

**NOTES:**

- ALL JAMB EXTENSIONS AND PADS TO BE SUPPLIED BY OTHERS.
- ALL ELECTRICAL WIRING (INCLUDING LOW VOLTAGE) BY OTHERS.

**APPROVED FOR MANUFACTURING BY:**  
 Nom:.....  
 Signature:.....  
 Date:.....

MODEL	QTY.	No DOOR	CLEARANCE REQ.			DEPTH	SECT.	GLASS
			A	B	C			
SENTINEL MARK II-166	X		XXmm	550mm	100mm	610mm	X	GLASS TYPE

**THERMOSTOP INC.**  
 3775 BOULEVARD LOSCH, ST-HUBERT, QUÉBEC J3Y 5T7  
 PROJECT NAME : XXXXXXXXXXXX  
 DISTRIBUTOR : XXXXXXXXXXXX  
 CONTRACTOR : XXXXXXXXXXXX  
 ARCHITECT : XXXXXXXXXXXX

**NOTE :**  
 DRAWINGS NOT TO SCALE  
 ALL DIMENSIONS ARE IN mm

DATE	DRAWN BY	VERIFIED BY	QUOTE No.	DRAWING No.	REVISION:
xx/xx/xxxx	X.X.	L.H.	XXXXXX	xx/xx	XX