

**INTERIOR ELEVATION**

**THERMOSTOP MODEL SENTINEL MARK II-200**  
DOOR THICKNESS = 50mm (2")

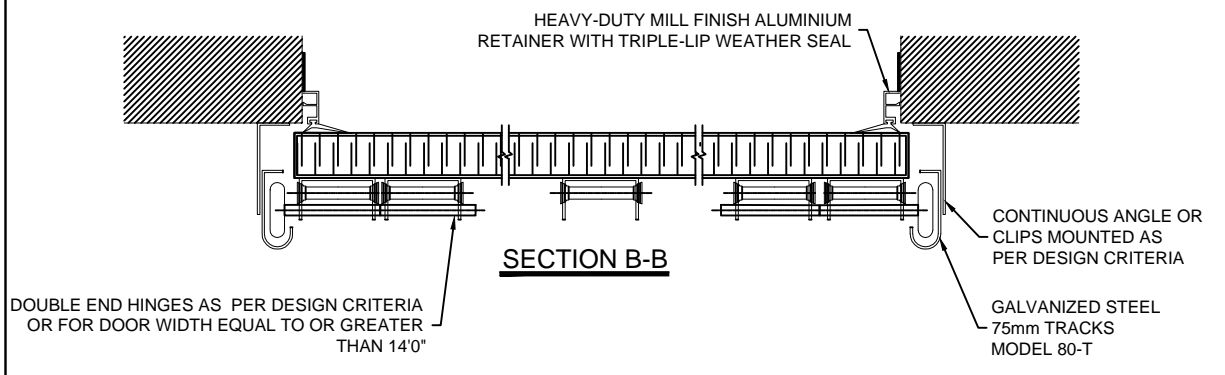

APPROVED FOR MANUFACTURING BY:  
Name:.....  
Signature:.....  
Date:.....

MODEL	QTY.	DOOR		No. of PAN.	No. of SECT.	OPERATION	
		WIDTH	HEIGHT				
SENTINEL MARK II-200	X	XXXXmm	XXXXmm	X	X	ELECTRIC OPERATOR BY THERMOSTOP	
		XX' XX"	XX' XX"				
	OPENING						
		XXXXmm	XXXXmm				
		XX' XX"	XX' XX"				

**THERMOSTOP INC.**  
3775 BOULEVARD LOSCH, ST-HUBERT, QUÉBEC J3Y 5T7  
PROJECT NAME : XXXXXXXXXXXX  
DISTRIBUTOR : XXXXXXXXXXXX  
CONTRACTOR : XXXXXXXXXXXX  
ARCHITECT : XXXXXXXXXXXX

NOTES:  
DRAWINGS NOT TO SCALE  
ALL DIMENSIONS ARE IN mm

DATE	DRAWN BY	VERIFIED BY	QUOTE No.	DRAWING No.	REVISION:
xx/xx/xxxx	X.X.	L.H.	XXXXXX	XX/XX	XX

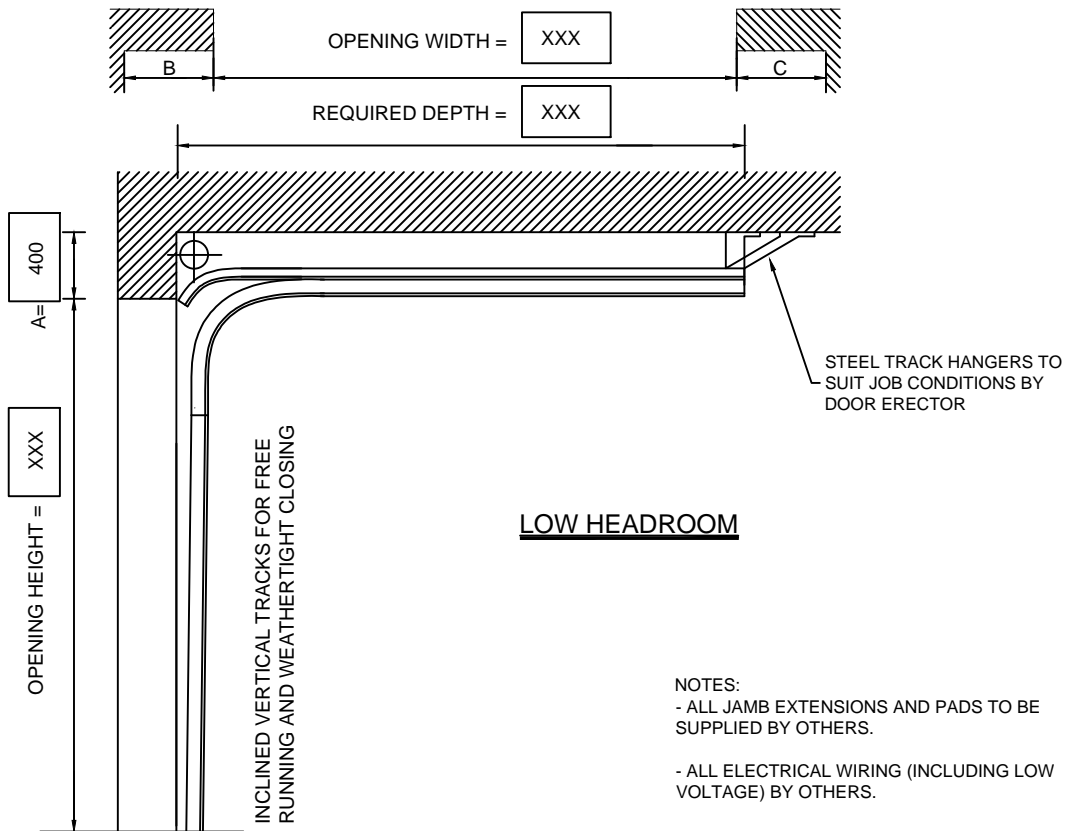
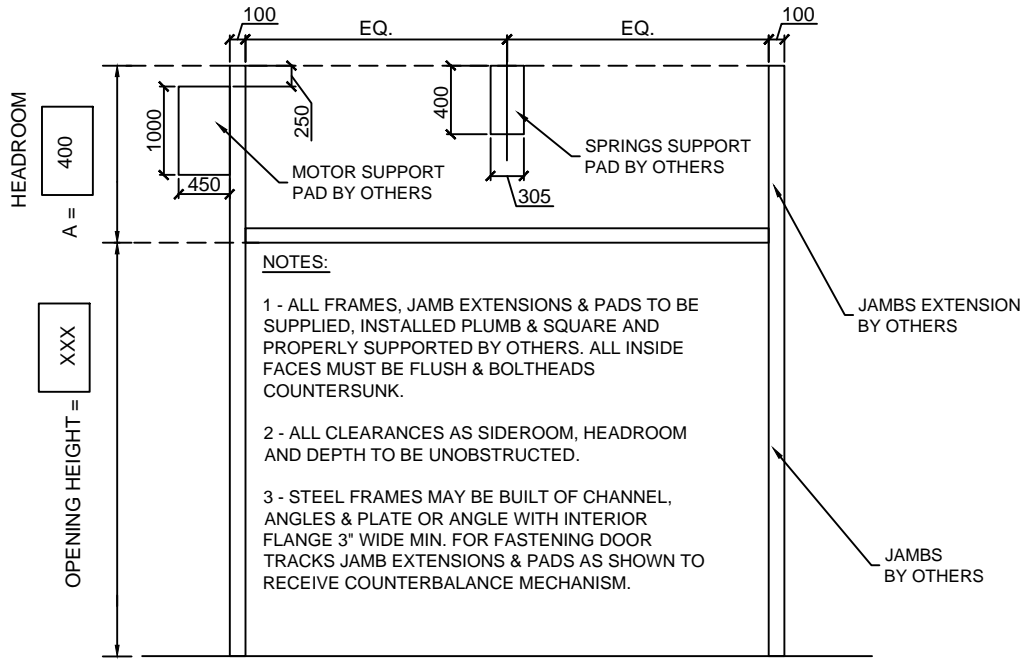

**APPROVED FOR MANUFACTURING BY:**  
 Nom:.....  
 Signature:.....  
 Date:.....

MODEL	QTY.	No DOOR	CLEARANCE REQ.			DEPTH	SECT.	GLASS
			A	B	C			
SENTINEL MARK II-200	X		400mm	550mm	100mm	XXmm	X	GLASS TYPE

**THERMOSTOP INC.**  
 3775 BOULEVARD LOSCH, ST-HUBERT, QUÉBEC J3Y 5T7  
 PROJECT NAME : XXXXXXXXXXXX  
 DISTRIBUTOR : XXXXXXXXXXXX  
 CONTRACTOR : XXXXXXXXXXXX  
 ARCHITECT : XXXXXXXXXXXX

**NOTE :**  
 DRAWINGS NOT TO SCALE  
 ALL DIMENSIONS ARE IN mm

DATE	DRAWN BY	VERIFIED BY	QUOTE No.	DRAWING No.	REVISION:
XX/XX/XXXX	X.X.	L.H.	XXXXXXXX	XX/XX	XX

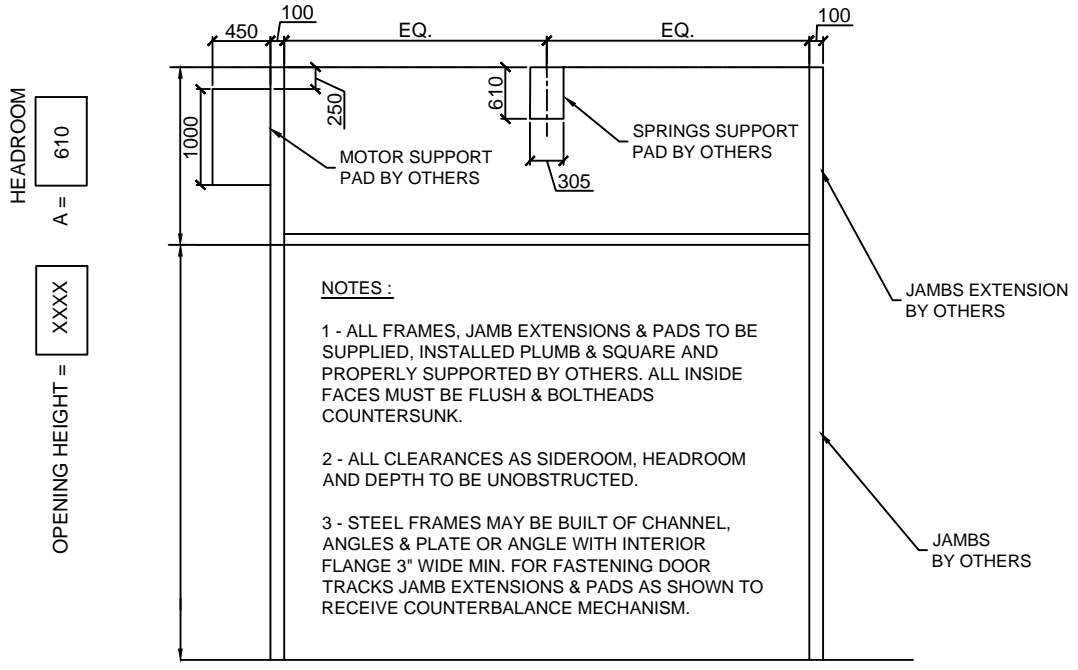

**NOTES :**

- 1 - ALL FRAMES, JAMB EXTENSIONS & PADS TO BE SUPPLIED, INSTALLED PLUMB & SQUARE AND PROPERLY SUPPORTED BY OTHERS. ALL INSIDE FACES MUST BE FLUSH & BOLTHEADS COUNTERSUNK.
- 2 - ALL CLEARANCES AS SIDEROOM, HEADROOM AND DEPTH TO BE UNOBSTRUCTED.
- 3 - STEEL FRAMES MAY BE BUILT OF CHANNEL, ANGLES & PLATE OR ANGLE WITH INTERIOR FLANGE 3" WIDE MIN. FOR FASTENING DOOR TRACKS JAMB EXTENSIONS & PADS AS SHOWN TO RECEIVE COUNTERBALANCE MECHANISM.

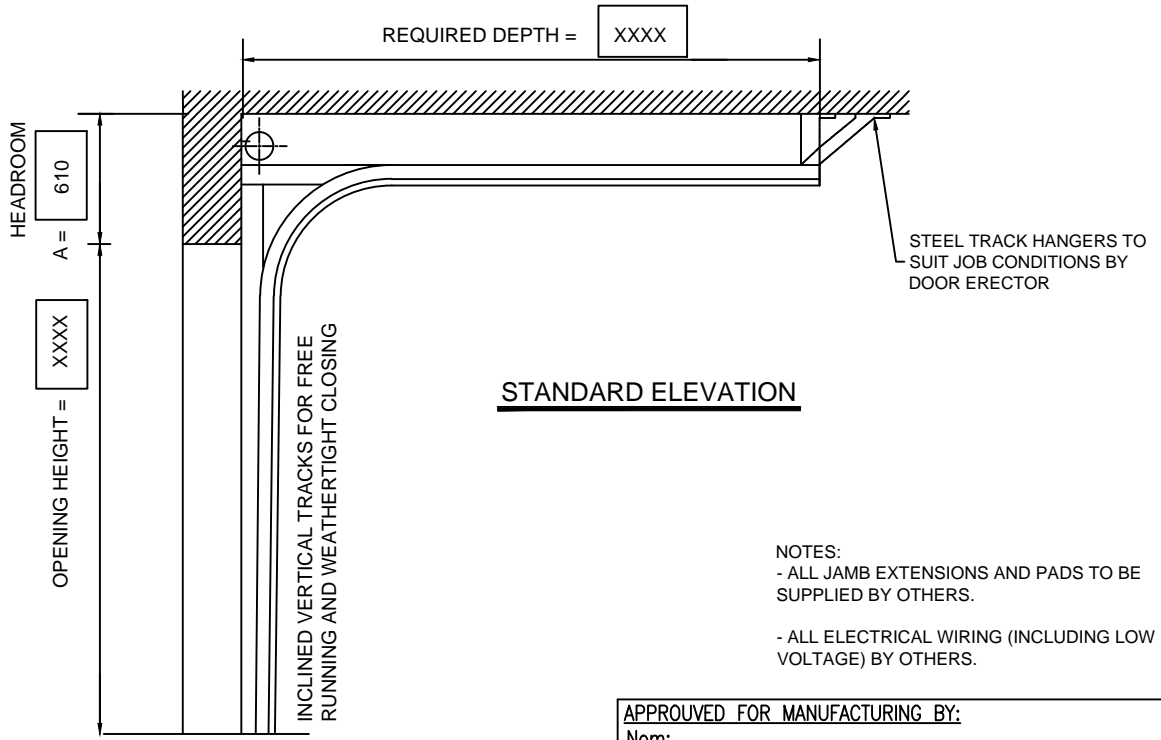
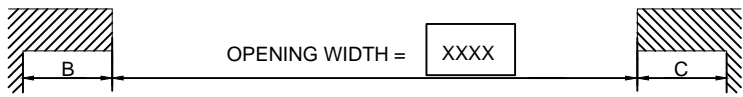

**NOTES:**

- ALL JAMB EXTENSIONS AND PADS TO BE SUPPLIED BY OTHERS.
- ALL ELECTRICAL WIRING (INCLUDING LOW VOLTAGE) BY OTHERS.

**APPROVED FOR MANUFACTURING BY:**  
 Nom:.....  
 Signature:.....  
 Date:.....

MODEL	QTY.	No DOOR	CLEARANCE REQ.			DEPTH	SECT.	GLASS
			A	B	C			
SENTINEL MARK II-200	X		610mm	550mm	100mm	XXmm	X	GLASS TYPE

**THERMOSTOP INC.**  
 3775 BOULEVARD LOSCH, ST-HUBERT, QUÉBEC J3Y 5T7  
 PROJECT NAME : XXXXXXXXXXXX  
 DISTRIBUTOR : XXXXXXXXXXXX  
 CONTRACTOR : XXXXXXXXXXXX  
 ARCHITECT : XXXXXXXXXXXX

**NOTE :**  
 DRAWINGS NOT TO SCALE  
 ALL DIMENSIONS ARE IN mm

DATE	DRAWN BY	VERIFIED BY	QUOTE No.	DRAWING No.	REVISION:
XX/XX/XXXX	X.X.	L.H.	XXXXXX	XX/XX	XX

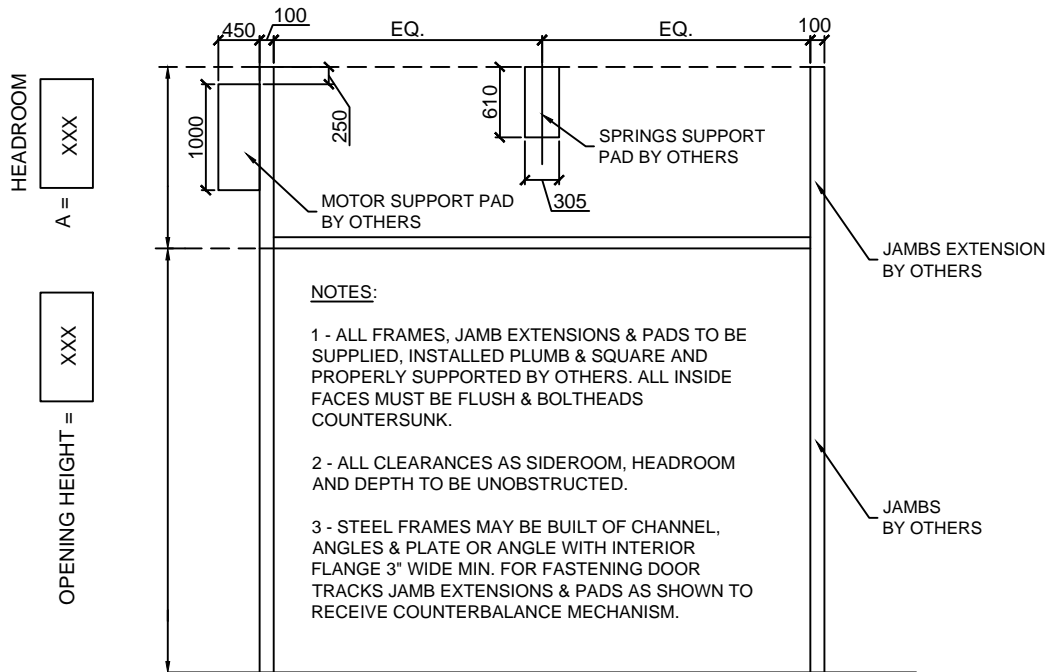

**NOTES:**

- 1 - ALL FRAMES, JAMB EXTENSIONS & PADS TO BE SUPPLIED, INSTALLED PLUMB & SQUARE AND PROPERLY SUPPORTED BY OTHERS. ALL INSIDE FACES MUST BE FLUSH & BOLTHEADS COUNTERSUNK.
- 2 - ALL CLEARANCES AS SIDEROOM, HEADROOM AND DEPTH TO BE UNOBSTRUCTED.
- 3 - STEEL FRAMES MAY BE BUILT OF CHANNEL, ANGLES & PLATE OR ANGLE WITH INTERIOR FLANGE 3" WIDE MIN. FOR FASTENING DOOR TRACKS JAMB EXTENSIONS & PADS AS SHOWN TO RECEIVE COUNTERBALANCE MECHANISM.

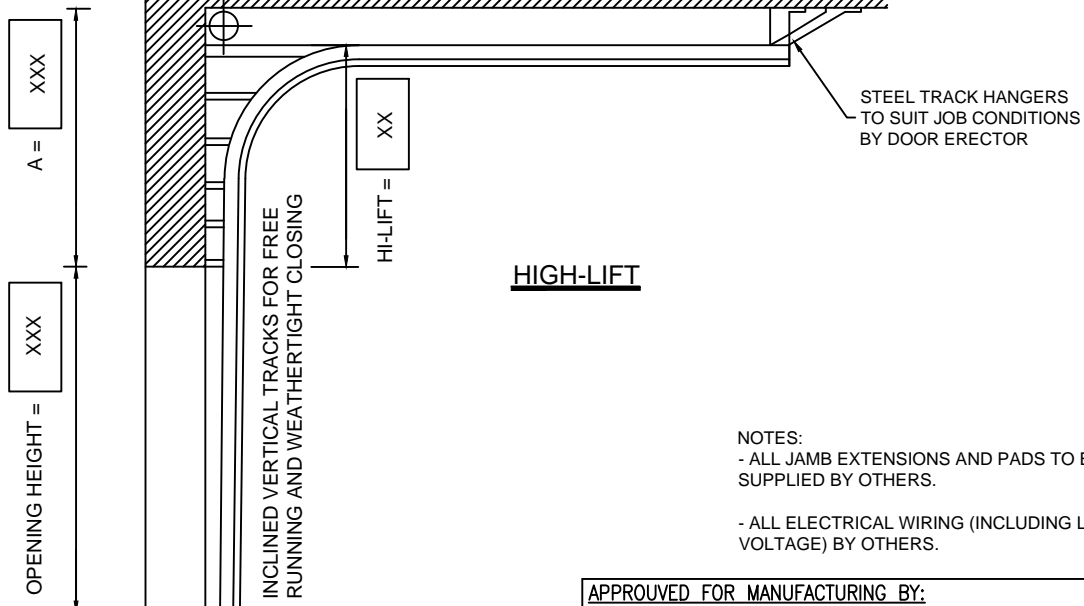
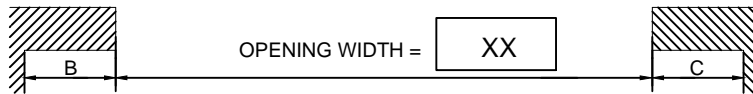

**NOTES:**

- ALL JAMB EXTENSIONS AND PADS TO BE SUPPLIED BY OTHERS.
- ALL ELECTRICAL WIRING (INCLUDING LOW VOLTAGE) BY OTHERS.

**APPROVED FOR MANUFACTURING BY:**  
 Nom:.....  
 Signature:.....  
 Date:.....

MODEL	QTY.	No DOOR	CLEARANCE REQ.			DEPTH	SECT.	GLASS
			A	B	C			
SENTINEL MARK II-200	X		XXmm	550mm	100mm	XXmm	X	GLASS TYPE

NOTE:  
 DRAWINGS NOT TO SCALE  
 ALL DIMENSIONS ARE IN mm

**THERMOSTOP INC.**  
 3775 BOULEVARD LOSCH, ST-HUBERT, QUÉBEC J3Y 5T7

PROJECT NAME : XXXXXXXXXXXX  
 DISTRIBUTOR : XXXXXXXXXXXX  
 CONTRACTOR : XXXXXXXXXXXX  
 ARCHITECT : XXXXXXXXXXXX

DATE XX/XX/XXXX	DRAWN BY X.X.	VERIFIED BY L.H.	QUOTE No. XXXXXXX	DRAWING No. XX/XX	REVISION: XX
--------------------	------------------	---------------------	----------------------	----------------------	-----------------

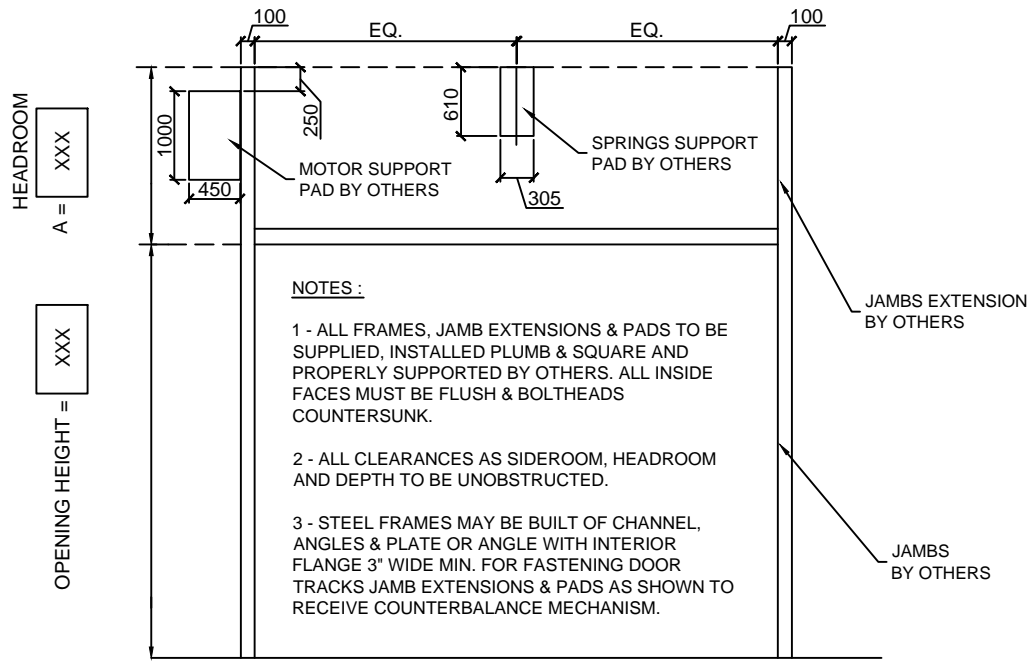

**NOTES :**

- 1 - ALL FRAMES, JAMB EXTENSIONS & PADS TO BE SUPPLIED, INSTALLED PLUMB & SQUARE AND PROPERLY SUPPORTED BY OTHERS. ALL INSIDE FACES MUST BE FLUSH & BOLTHEADS COUNTERSUNK.
- 2 - ALL CLEARANCES AS SIDEROOM, HEADROOM AND DEPTH TO BE UNOBSTRUCTED.
- 3 - STEEL FRAMES MAY BE BUILT OF CHANNEL, ANGLES & PLATE OR ANGLE WITH INTERIOR FLANGE 3" WIDE MIN. FOR FASTENING DOOR TRACKS JAMB EXTENSIONS & PADS AS SHOWN TO RECEIVE COUNTERBALANCE MECHANISM.

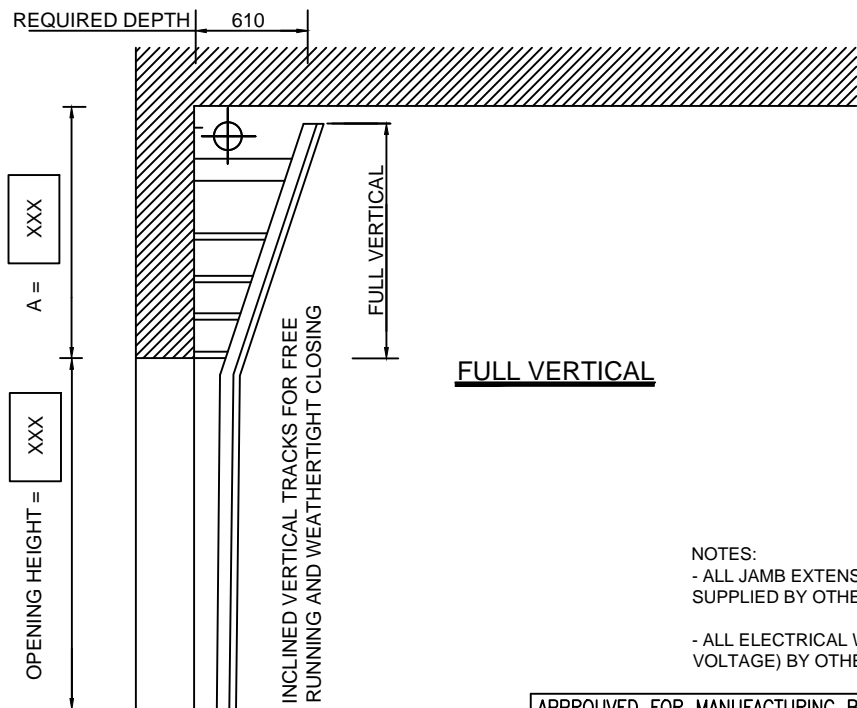
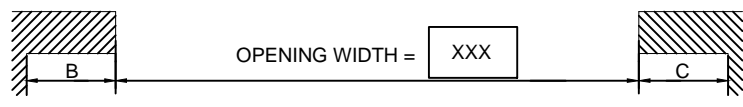

**NOTES:**

- ALL JAMB EXTENSIONS AND PADS TO BE SUPPLIED BY OTHERS.
- ALL ELECTRICAL WIRING (INCLUDING LOW VOLTAGE) BY OTHERS.

**APPROVED FOR MANUFACTURING BY:**  
 Nom:.....  
 Signature:.....  
 Date:.....

MODEL	QTY.	No DOOR	CLEARANCE REQ.			DEPTH	SECT.	GLASS
			A	B	C			
SENTINEL MARK II-200	X		XXmm	550mm	100mm	610mm	X	GLASS TYPE

**THERMOSTOP INC.**  
 3775 BOULEVARD LOSCH, ST-HUBERT, QUÉBEC J3Y 5T7  
 PROJECT NAME : XXXXXXXXXXXX  
 DISTRIBUTOR : XXXXXXXXXXXX  
 CONTRACTOR : XXXXXXXXXXXX  
 ARCHITECT : XXXXXXXXXXXX

**NOTE :**  
 DRAWINGS NOT TO SCALE  
 ALL DIMENSIONS ARE IN mm

DATE	DRAWN BY	VERIFIED BY	QUOTE No.	DRAWING No.	REVISION
xx/xx/xxxx	X.X.	L.H.	XXXXXX	xx/xx	XX