

INTERIOR ELEVATION

NOTE:
DOOR TO OVERLAP OPENING BY 75mm ON EACH SIDE AND AT HEADER TO ACCOMMODATE ACOUSTIC WALL COMPRESSION SEALS

**THERMOSTOP MODEL
SOUND SENTRY STC-34
DOOR THICKNESS = 4" (100 mm)**

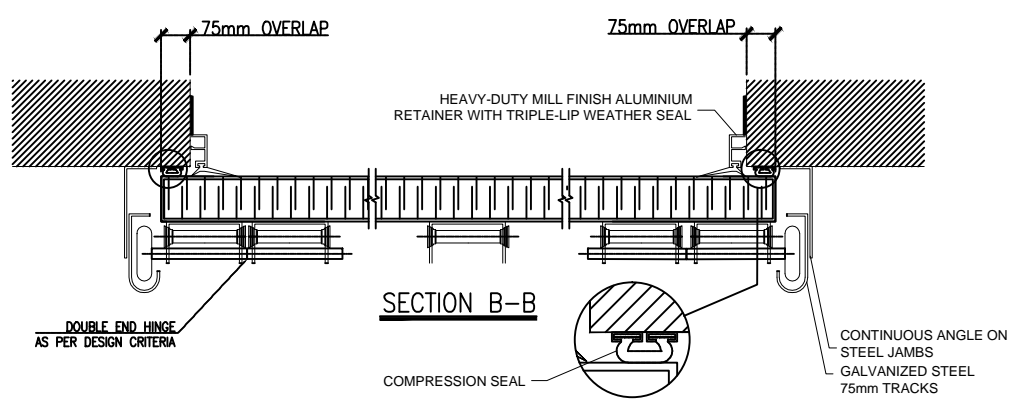

APPROVED FOR MANUFACTURING BY:
Name:.....
Signature:.....
Date:.....

MODEL	QTY.	DOOR		No. OF PAN.	No. OF SECT.	OPERATION
		WIDTH.	HEIGHT.			
SOUND SENTRY STC 34	X	XX' X"	XX' XX"	X	X	ELECTRIC OPERATOR BY THERMOSTOP
		XXXX mm	XXXX mm			
		OPENING				
		XX' XX"	XX' XX"			

Notes:
DRAWINGS NOT TO SCALE

THERMOSTOP INC.
3775 BOULEVARD LOSCH, ST-HUBERT, QUÉBEC J5Y 5T7
PROJECT NAME: XXXXXXXXX
DISTRIBUTOR : XXXXXXXX
CONTRACTOR : XXXXXXXX
ARCHITECT : XXXXXXXX

DATE	DRAWN BY	VERIFIED BY	QUOTE No.	DRAWING No.	REVISION
XX/XX/XXXX	X.X.	L.H.	XXXXXXX	XX/XX	XX

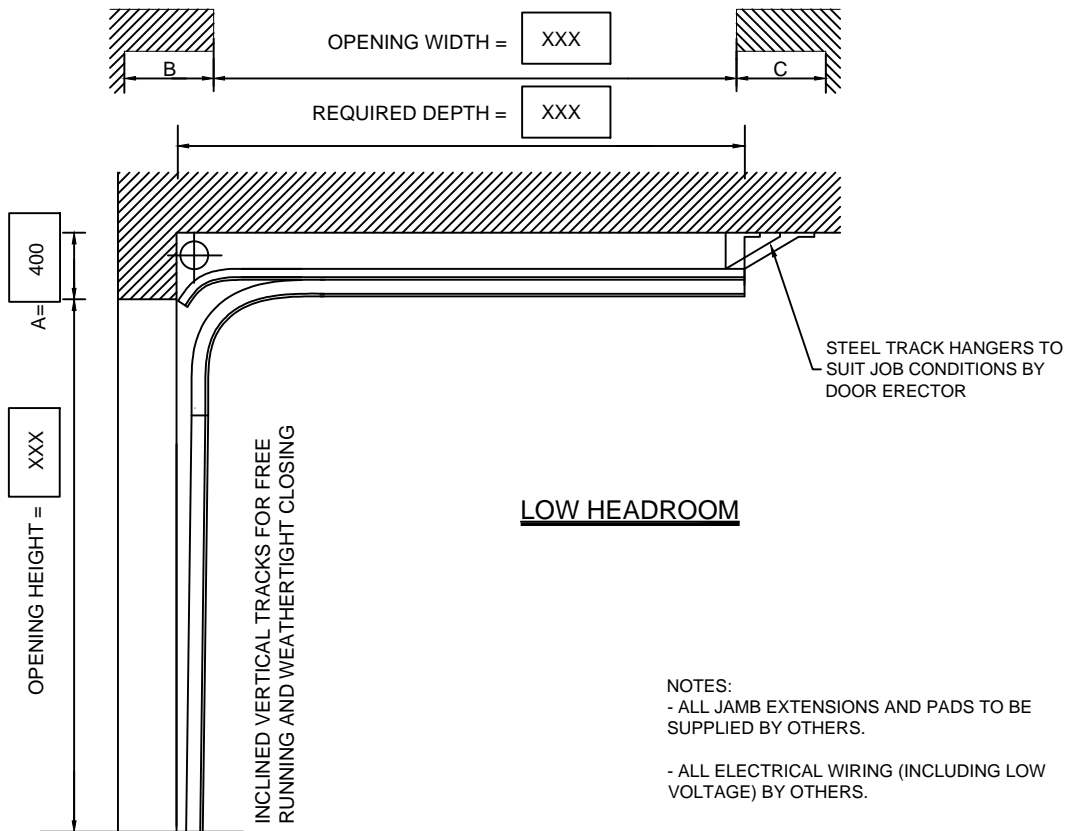
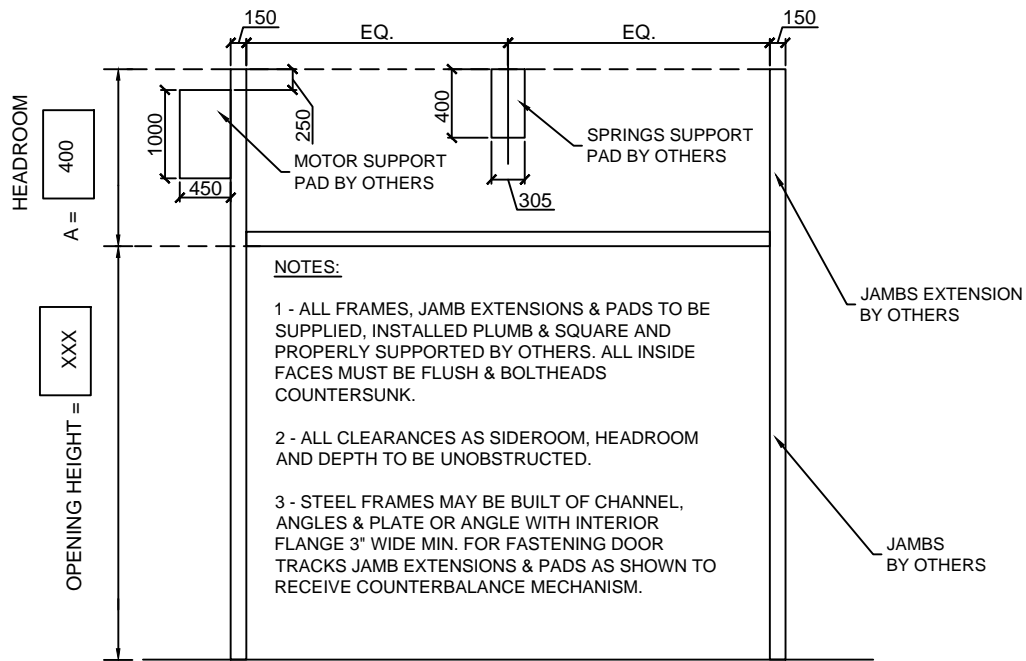

APPROVED FOR MANUFACTURING BY:

Nom:.....

Signature:.....

Date:.....

MODEL	QTY.	No DOOR	CLEARANCE REQ.			DEPTH	SECT.	GLASS
			A	B	C			
SOUND SENTRY STC 34	x		400mm	600mm	150mm	XXmm	x	GLASS TYPE

NOTE:
DRAWINGS NOT TO SCALE

THERMOSTOP INC.

3775 BOULEVARD LOSCH, ST-HUBERT, QUÉBEC J3Y 5T7

PROJECT NAME : XXXXXXXXXXXX

DISTRIBUTOR : XXXXXXXXXXXX

CONTRACTOR : XXXXXXXXXXXX

ARCHITECT : XXXXXXXXXXXX

DATE	DRAWN BY	VERIFIED BY	QUOTE No.	DRAWING No.	REVISION:
xx/xx/xxxx	x.x.	L.H.	xxxxxxx	xx/xx	xx

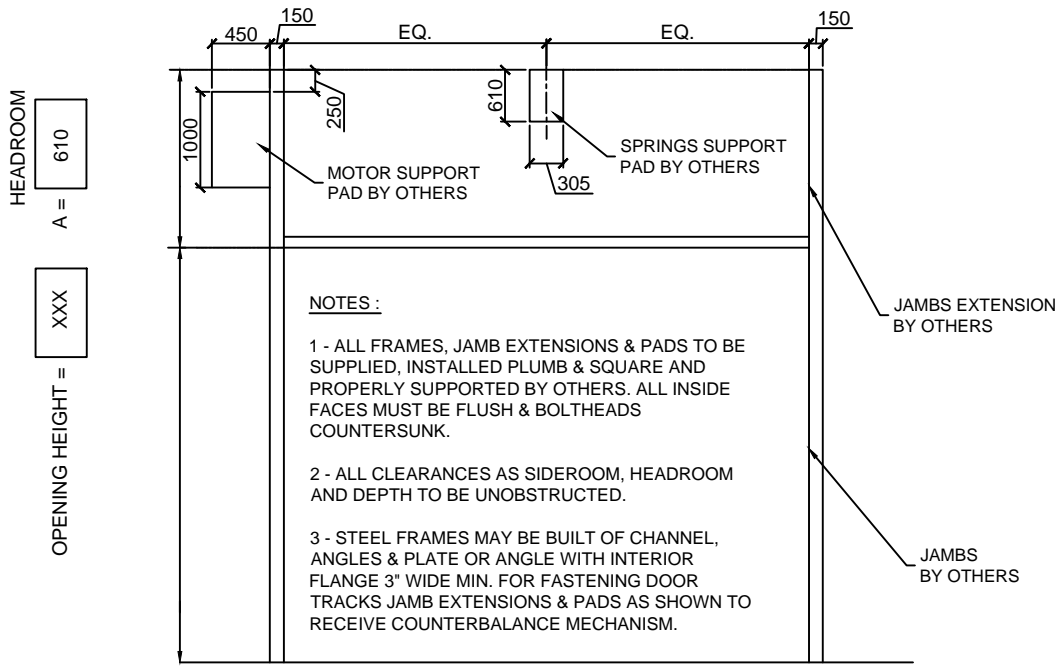

NOTES :

- 1 - ALL FRAMES, JAMB EXTENSIONS & PADS TO BE SUPPLIED, INSTALLED PLUMB & SQUARE AND PROPERLY SUPPORTED BY OTHERS. ALL INSIDE FACES MUST BE FLUSH & BOLTHEADS COUNTERSUNK.
- 2 - ALL CLEARANCES AS SIDEROOM, HEADROOM AND DEPTH TO BE UNOBSTRUCTED.
- 3 - STEEL FRAMES MAY BE BUILT OF CHANNEL, ANGLES & PLATE OR ANGLE WITH INTERIOR FLANGE 3" WIDE MIN. FOR FASTENING DOOR TRACKS JAMB EXTENSIONS & PADS AS SHOWN TO RECEIVE COUNTERBALANCE MECHANISM.

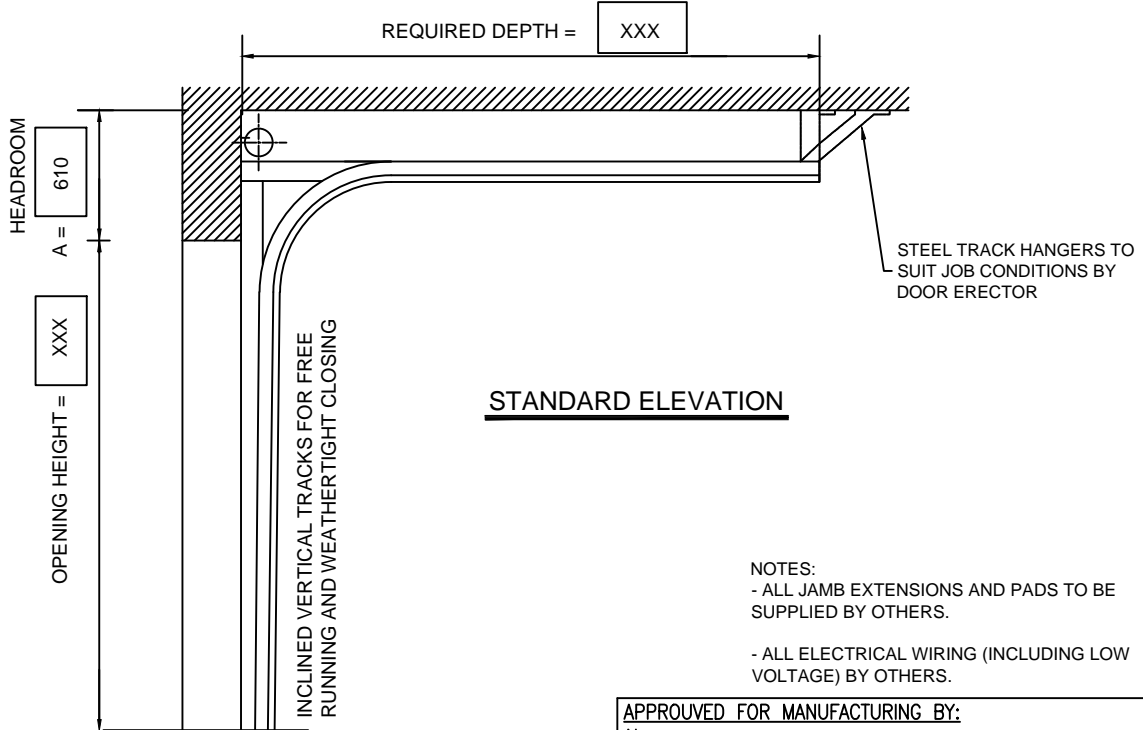
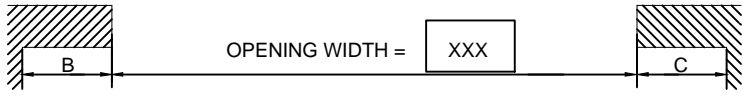

STANDARD ELEVATION

NOTES:

- ALL JAMB EXTENSIONS AND PADS TO BE SUPPLIED BY OTHERS.
- ALL ELECTRICAL WIRING (INCLUDING LOW VOLTAGE) BY OTHERS.

APPROVED FOR MANUFACTURING BY:
 Nom:.....
 Signature:.....
 Date:.....

MODEL	QTY.	No DOOR	CLEARANCE REQ.			DEPTH	SECT.	GLASS
			A	B	C			
SOUND SENTRY STC 34	X		610mm	600mm	150mm	XXmm	X	GLASS TYPE

THERMOSTOP INC.
 3775 BOULEVARD LOSCH, ST-HUBERT, QUÉBEC J3Y 5T7
 PROJECT NAME : XXXXXXXXXXXX
 DISTRIBUTOR : XXXXXXXXXXXX
 CONTRACTOR : XXXXXXXXXXXX
 ARCHITECT : XXXXXXXXXXXX

NOTE :
 DRAWINGS NOT TO SCALE
 ALL DIMENSIONS ARE IN mm

DATE	DRAWN BY	VERIFIED BY	QUOTE No.	DRAWING No.	REVISION:
xx/xx/xxxx	X.X.	L.H.	XXXXXXX	XX/XX	XX

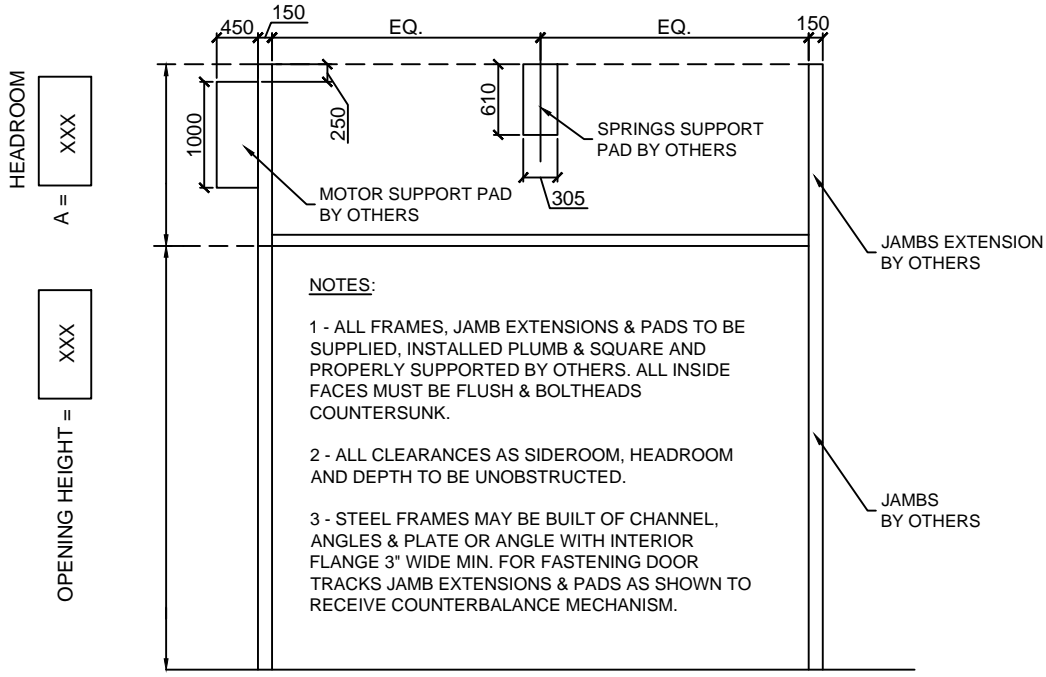

NOTES:

- 1 - ALL FRAMES, JAMB EXTENSIONS & PADS TO BE SUPPLIED, INSTALLED PLUMB & SQUARE AND PROPERLY SUPPORTED BY OTHERS. ALL INSIDE FACES MUST BE FLUSH & BOLTHEADS COUNTERSUNK.
- 2 - ALL CLEARANCES AS SIDEROOM, HEADROOM AND DEPTH TO BE UNOBSTRUCTED.
- 3 - STEEL FRAMES MAY BE BUILT OF CHANNEL, ANGLES & PLATE OR ANGLE WITH INTERIOR FLANGE 3" WIDE MIN. FOR FASTENING DOOR TRACKS JAMB EXTENSIONS & PADS AS SHOWN TO RECEIVE COUNTERBALANCE MECHANISM.

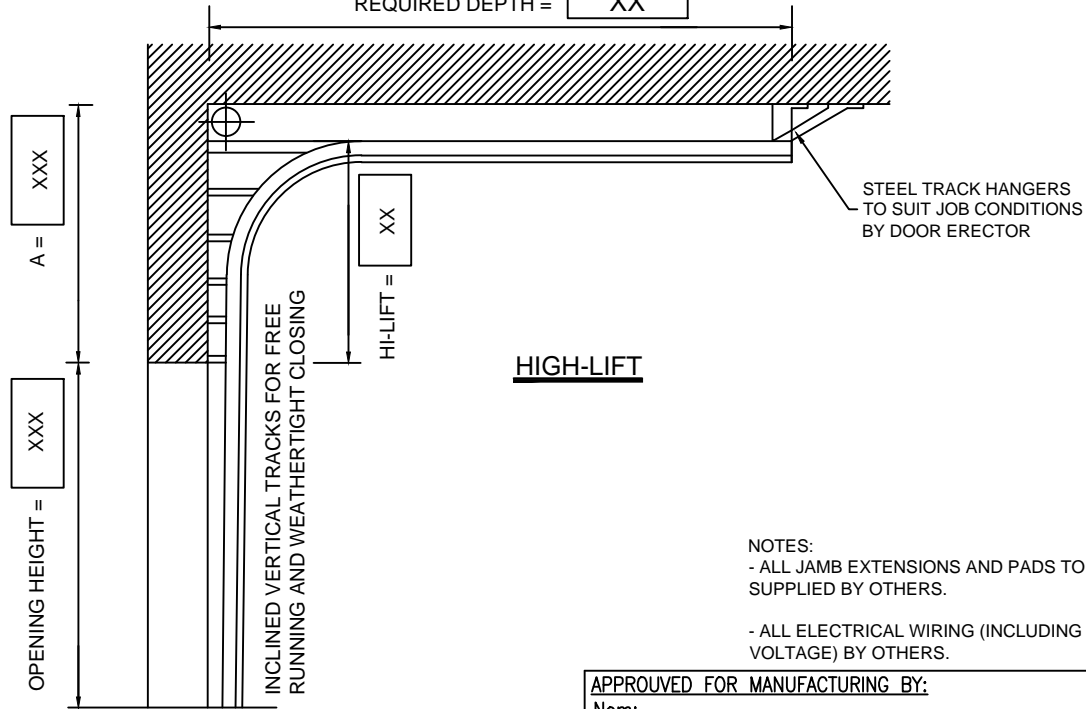
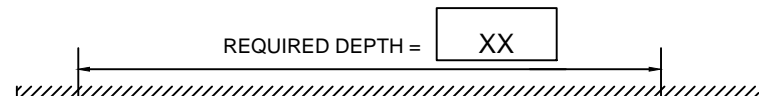
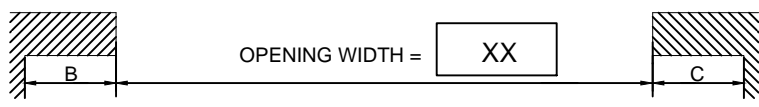

NOTES:

- ALL JAMB EXTENSIONS AND PADS TO BE SUPPLIED BY OTHERS.
- ALL ELECTRICAL WIRING (INCLUDING LOW VOLTAGE) BY OTHERS.

APPROVED FOR MANUFACTURING BY:
 Nom:.....
 Signature:.....
 Date:.....

MODEL	QTY.	No DOOR	CLEARANCE REQ.			DEPTH	SECT.	GLASS
			A	B	C			
SOUND SENTRY STC 34	X		XXmm	600mm	150mm	XXmm	X	GLASS TYPE

NOTE:
DRAWINGS NOT TO SCALE

THERMOSTOP INC.
 3775 BOULEVARD LOSCH, ST-HUBERT, QUÉBEC J3Y 5T7
 PROJECT NAME : XXXXXXXXXXXX
 DISTRIBUTOR : XXXXXXXXXXXX
 CONTRACTOR : XXXXXXXXXXXX
 ARCHITECT : XXXXXXXXXXXX

DATE	DRAWN BY	VERIFIED BY	QUOTE No.	DRAWING No.	REVISION:
xx/xx/xxxx	X.X.	L.H.	xxxxxxx	xx/xx	xx

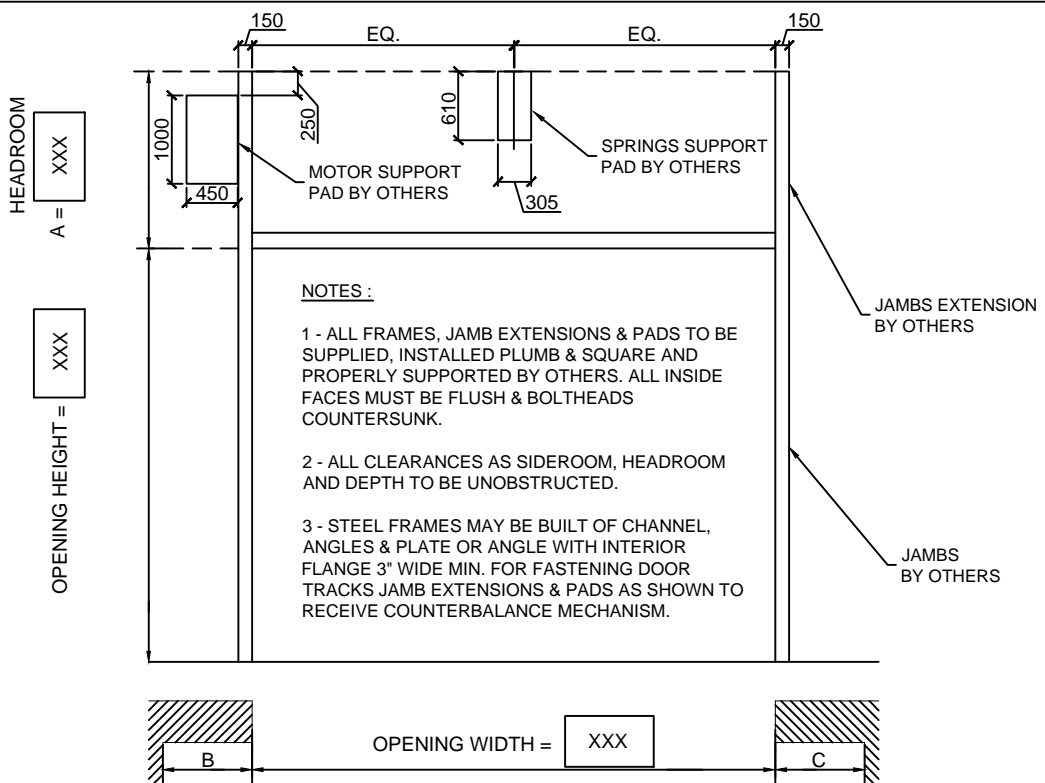

NOTES :

- 1 - ALL FRAMES, JAMB EXTENSIONS & PADS TO BE SUPPLIED, INSTALLED PLUMB & SQUARE AND PROPERLY SUPPORTED BY OTHERS. ALL INSIDE FACES MUST BE FLUSH & BOLTHEADS COUNTERSUNK.
- 2 - ALL CLEARANCES AS SIDEROOM, HEADROOM AND DEPTH TO BE UNOBSTRUCTED.
- 3 - STEEL FRAMES MAY BE BUILT OF CHANNEL, ANGLES & PLATE OR ANGLE WITH INTERIOR FLANGE 3" WIDE MIN. FOR FASTENING DOOR TRACKS JAMB EXTENSIONS & PADS AS SHOWN TO RECEIVE COUNTERBALANCE MECHANISM.

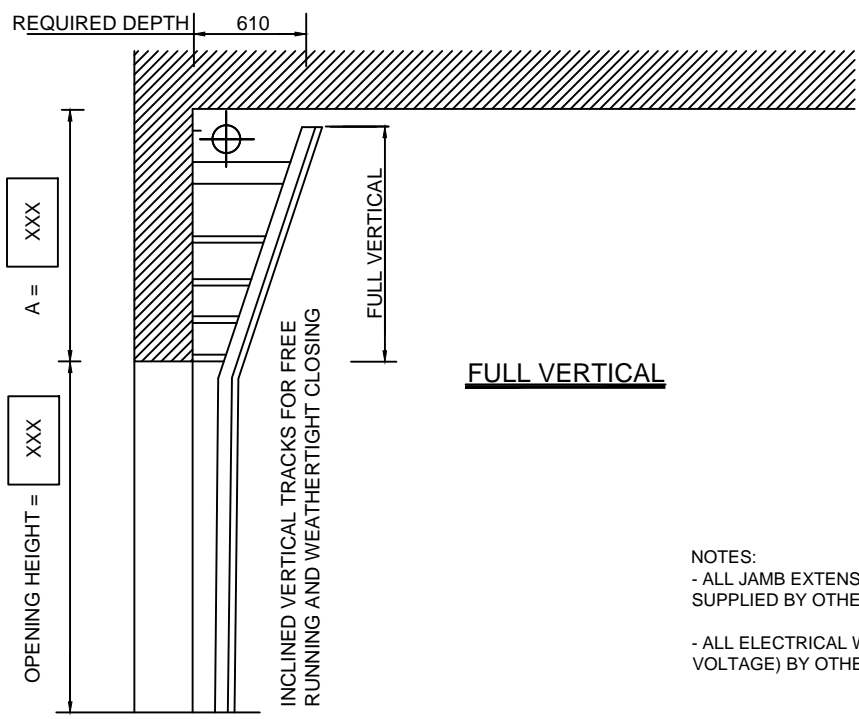

NOTES:

- ALL JAMB EXTENSIONS AND PADS TO BE SUPPLIED BY OTHERS.
- ALL ELECTRICAL WIRING (INCLUDING LOW VOLTAGE) BY OTHERS.

APPROVED FOR MANUFACTURING BY:					
Nom:.....					
Signature:.....					
Date:.....					
THERMOSTOP INC.					
3775 BOULEVARD LOSCH, ST-HUBERT, QUÉBEC J3Y 5T7					
PROJECT NAME : XXXXXXXXXXXX					
DISTRIBUTOR : XXXXXXXXXXXX					
CONTRACTOR : XXXXXXXXXXXX					
ARCHITECT : XXXXXXXXXXXX					
DATE	DRAWN BY	VERIFIED BY	QUOTE No.	DRAWING No.	REVISION:
XX/XX/XXXX	X.X.	L.H.	XXXXXX	XX/XX	XX

MODEL	QTY.	No DOOR	CLEARANCE REQ.			DEPTH	SECT.	GLASS
			A	B	C			
SOUND SENTRY STC 34	X		XXXmm	600mm	150mm	610mm	X	GLASS TYPE

NOTE :
DRAWINGS NOT TO SCALE